

EPSON®

PowerLite® 505c/715c

User's Guide



EPSON® PowerLite® 505c/715c

Multimedia Projector



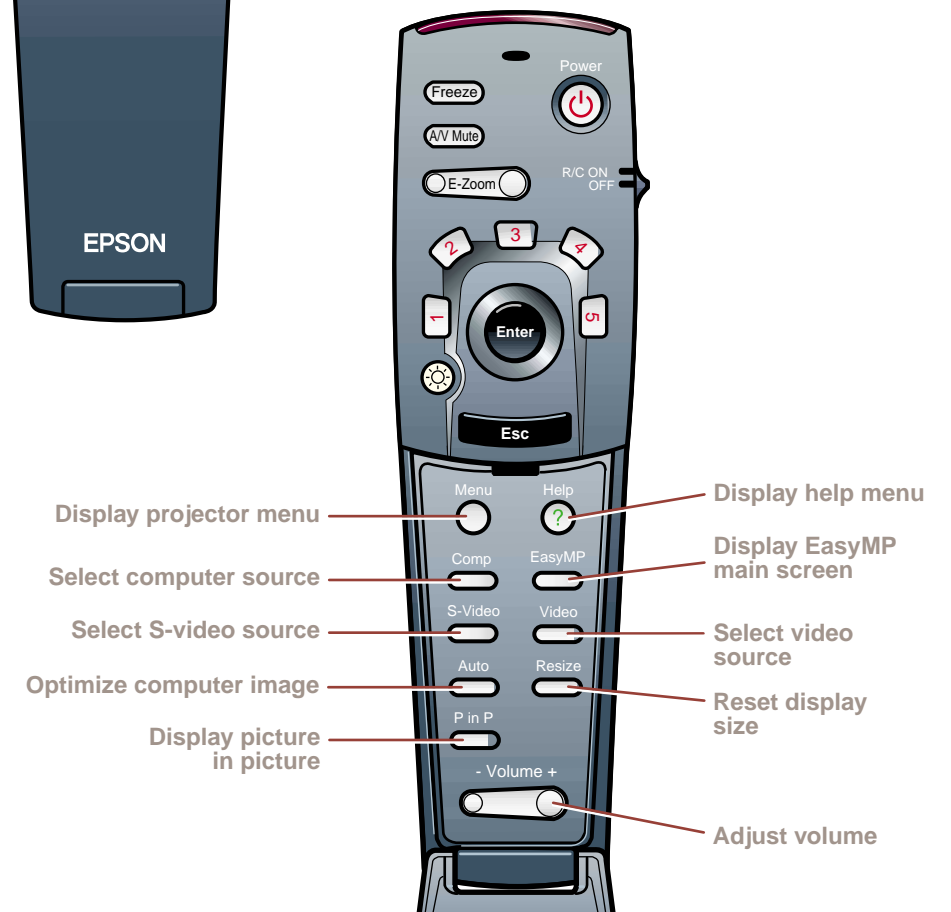
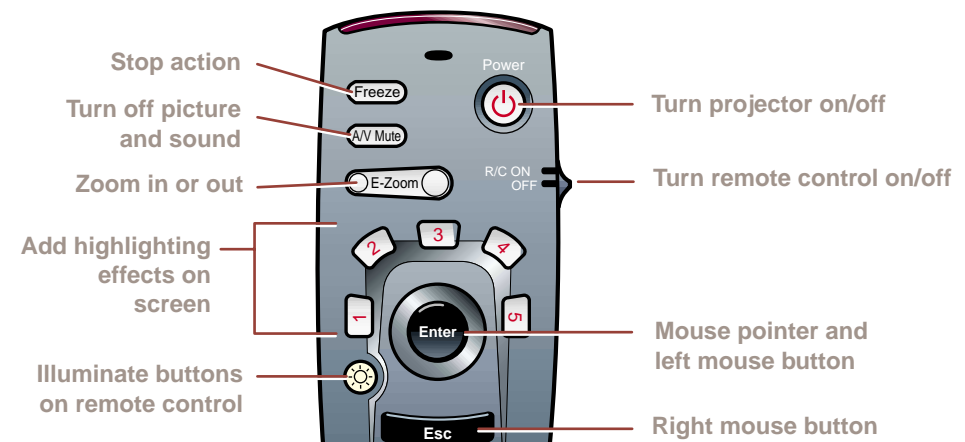
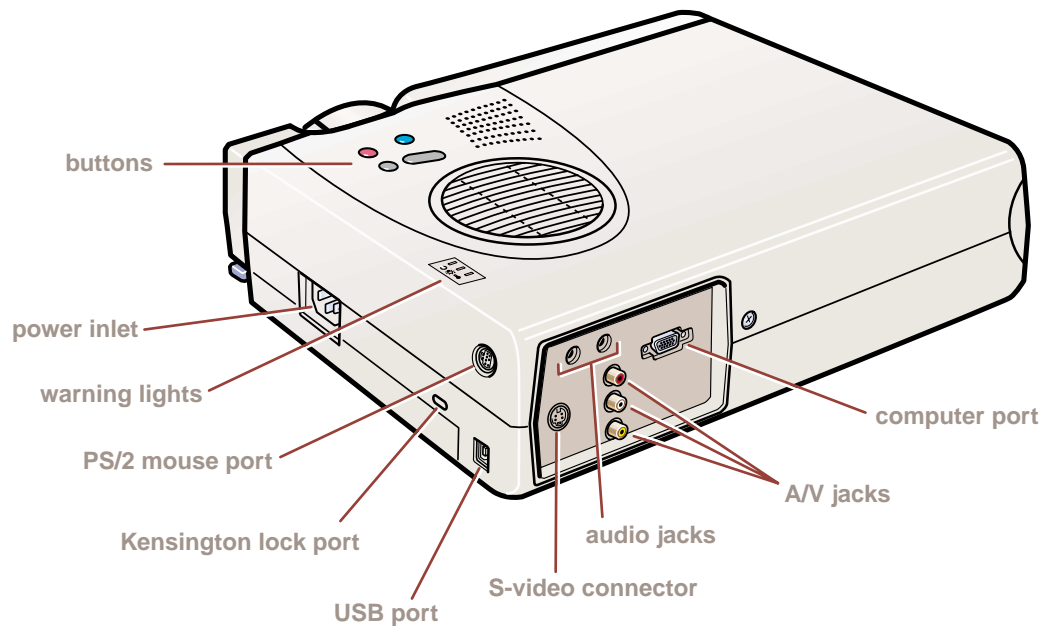
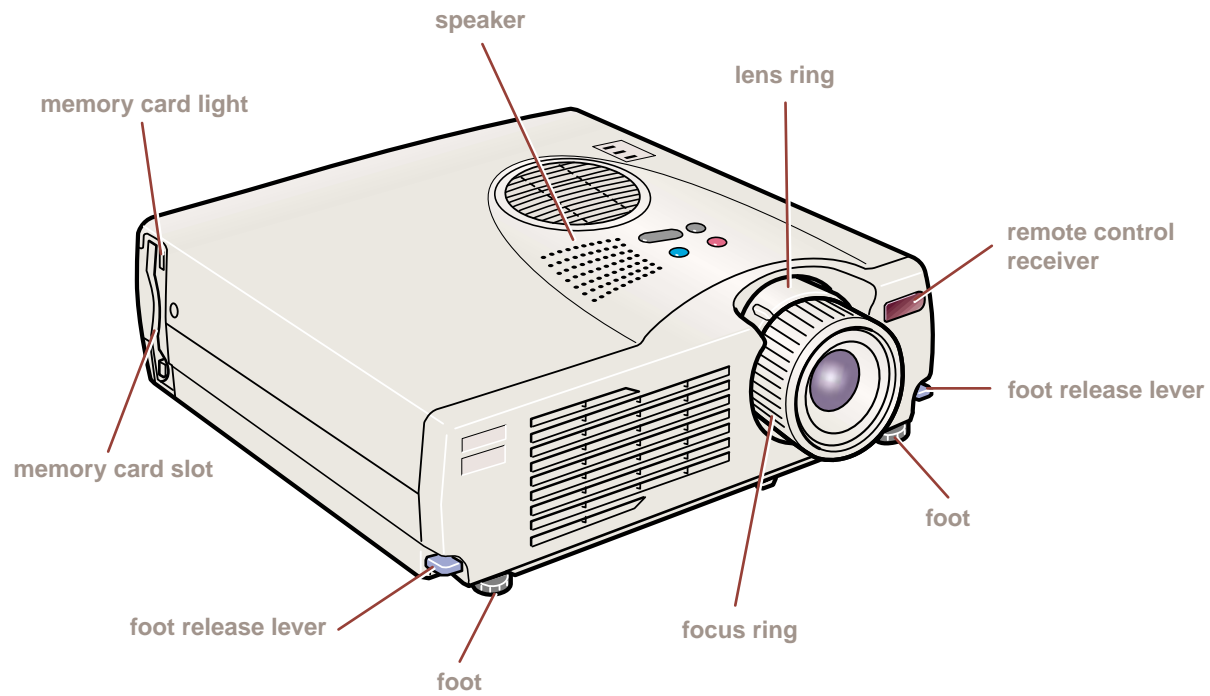

**EPSON® PowerLite® 505c/715c
Multimedia Projector**

User's Guide

Important Safety Information

WARNING: Never look into the projector lens when the lamp is turned on; the bright light can damage your eyes. Never let children look into the lens when it is on. Never open any cover on the projector, except the lamp and filter covers. Dangerous electrical voltages inside the projector can severely injure you. Except as specifically explained in this *User's Guide*, do not attempt to service this product yourself. Refer all servicing to qualified service personnel.

WARNING: The projector and its accessories come packaged in plastic bags. Keep plastic bags away from small children to avoid any risk of suffocation.

Caution: When you replace the lamp, never touch the new lamp with your bare hands; the invisible residue left by the oil on your hands may shorten the lamp life. Use a cloth or glove to handle the new lamp.

Copyright Notice

All rights reserved. No part of this publication may be reproduced, stored in a retrieval system, or transmitted in any form or by any means, electronic, mechanical, photocopying, recording, or otherwise, without the prior written permission of SEIKO EPSON CORPORATION. The information contained herein is designed only for use with this EPSON product. EPSON is not responsible for any use of this information as applied to other products.

Neither SEIKO EPSON CORPORATION nor its affiliates shall be liable to the purchaser of this product or third parties for damages, losses, costs, or expenses incurred by purchaser or third parties as a result of: accident, misuse, or abuse of this product or unauthorized modifications, repairs, or alterations to this product, or (excluding the U.S.) failure to strictly comply with SEIKO EPSON CORPORATION's operating and maintenance instructions.

SEIKO EPSON CORPORATION shall not be liable for any damages or problems arising from the use of any options or any consumable products other than those designated as Original EPSON Products or EPSON Approved Products by SEIKO EPSON CORPORATION.

EPSON is a registered trademark of SEIKO EPSON CORPORATION.

EPSON Extra Care is a service mark; EPSON Store, EasyMP, and SizeWise are trademarks; and PrivateLine, Presenters Club, and PowerLite are registered trademarks of Epson America, Inc.

General Notice: Other product names used herein are for identification purposes only and may be trademarks of their respective owners. EPSON disclaims any and all rights in those marks.

C

Contents

<i>Welcome</i>	1
Getting the Most from Your Projector	2
Using Your Documentation	3
Reading This Manual Online	3
Getting More Information	4
Registration and Warranty	5
Unpacking the Projector	6
Additional Components	7
Optional Accessories	8

1

<i>Setting Up the Projector</i>	9
Positioning the Projector	10
Connecting to a Laptop Computer	12
Connecting the Computer Cable	12
Connecting the Cable for Remote Mouse Control ...	13
Amplifying Computer Audio	14
Connecting to Video Sources	15
Connecting the RCA AV Cable	16
Connecting S-Video	17
Connecting Component Video Cables	18

2

<i>Using the Projector</i>	19
Turning On Your Equipment	20
Turning On the Projector	20
What To Do If You See a Blank Screen	22

Adjusting the Image	24
Focusing and Zooming Your Image	25
Adjusting the Height of Your Image	25
Adjusting the Image Shape	26
Shutting Down the Projector	27

3

<i>Using the Remote Control</i>	29
Turning On and Using the Remote Control	30
Installing Batteries	30
Turning On the Remote Control	30
Using the Remote Control	31
Controlling the Picture and Sound	32
Switching Between Picture Sources	32
Adjusting the Volume	32
Turning Off the Picture and Sound	33
Stopping Action	33
Zooming Your Image	33
Resizing the Image	34
Displaying Picture-in-Picture Video	34
Highlighting Your Presentation	35
Using the Pointer	36
Using Box Highlights	36
Spotlighting Your Image	37
Using Horizontal and Vertical Highlights	37
Using the Remote Control as a Wireless Mouse	38

4

<i>Creating Presentations for Your Projector</i> ...	39
Accessing the Memory Card	40
Moving the Memory Card from the Projector to Your Computer	40
Accessing the Memory Card Through a USB Cable ...	42
Installing EasyMP	43
System Requirements	43
Installing the Software	43

Creating a Scenario	44
Creating a Scenario by Drag and Drop	44
Creating a New Scenario File	46
Building a Scenario	47
Setting Up Transitions	49
Adding Computer Access or Video	50
Transferring Your Presentation to the Projector	52

5

<i>Presenting Without a Computer</i>	55
Presenting Your Scenario	56
Displaying Each Slide Manually	57
Editing Your Scenario	58
Rearranging and Hiding Slides	58
Changing the Continuous Play Setting	61
Previewing Slides	62
Changing Display Timing and Other Settings	63
Capturing Images	65
Saving Images on the Memory Card	65
Previewing Captured Images	66

6

<i>Fine-tuning the Projector</i>	69
Using the Projector's Menu System	70
Changing Menu Settings	71
Adjusting the Image	72
Repositioning the Image	73
Adjusting Image Appearance	73
Adjusting the Sound	74
Customizing the Highlighting Tools	75
Creating Your Own Startup Screen	77
Capturing the Image	77
Setting Up When the Image Displays	78
Customizing Projector Features	79
Setting Advanced Features	80
Viewing Lamp Usage and Other Information	81
Restoring the Default Settings	82

7

Maintaining and Transporting

<i>the Projector</i>	83
Cleaning the Lens	84
Cleaning the Projector Case	84
Cleaning and Replacing the Air Filter	85
Replacing the Lamp	86
Transporting the Projector	88

8

Solving Problems

Using On-Screen Help	90
What To Do When the Lights Flash	91
Solving Problems with the Image or Sound	94
Solving Problems with the Remote Control	100
Solving EasyMP Problems	101
EasyMP Error Messages	102
Where To Get Help	103
Telephone Support Services	103

A

Appendix A: Connecting to Additional Equipment

Installing the Projector	106
Connecting to an External Audio System	106
Connecting to a PC Desktop Computer	107
Connecting the Computer Cable	108
Connecting the Mouse Cable	109
Connecting the Audio Cable	110
Connecting to a Desktop Macintosh	111
Connecting the Computer Cable	111
Connecting the Mouse Cable	112
Connecting the Audio Cable	113
Connecting to a High-End Workstation	113

B *Appendix B: Notices*..... 115
Important Safety Instructions 115
Remote Control Information 117
Declaration of Conformity 118
FCC Compliance Statement 119

C *Appendix C: Technical Specifications*..... 121
General 121
Projection Lamp 122
Remote Control 122
Mouse Compatibility 122
Dimensions 122
Electrical 122
Environmental 123
Safety 123
Compatible Video Formats 124
Computer Video Port Pin Assignments 126

Index 127

W *Welcome*

The EPSON® PowerLite® 505c/715c are super-portable projectors that offer up to 1200 ANSI lumens of brightness. From boardrooms to auditoriums, your full-color presentations and videos will be bright and visible even in ordinary room lighting.

The new EPSON EasyMP™ feature lets you show a presentation without attaching a computer to the projector. Simply drag and drop your file and download it to the projector's memory card. You can rearrange your slides, display images captured from videos, or have your presentation play automatically.

Images are displayed at a resolution of 1024 × 768 pixels (PowerLite 715c) or 800 × 600 pixels (PowerLite 505c). Three 0.9-inch LCDs provide a 400:1 contrast ratio for incredibly vivid images and clear text. Support for component video and S-video contribute to theater-quality performance.

With EPSON's patented SizeWise™ chip, the projector supports computer displays ranging from VGA through UXGA (through SXGA on the PowerLite 505c).

You can connect the projector to a wide range of computers, including IBM® compatible PCs and laptops, Apple® Macintosh®, Power Macintosh™ series (including G3 and G4 systems), PowerBook® computers, many iMac™ and iBook™ series systems, and high-end workstations such as the Sun® SPARCstation.™

You can use any of the following video sources: VCR, DVD player, camcorder, digital camera, or laser disc player, supporting HDTV, NTSC, PAL, or SECAM video.

Getting the Most from Your Projector

Depending on your presentation, you can take advantage of any or all of these options:

- **Projecting without a computer**

With the EMP SlideMaker software on your computer, you can create presentations called “scenarios” from your PowerPoint® slides and add a variety of special effects. Then you can run your presentation with the remote control. See Chapters 4 and 5 for instructions.

- **Connecting to a laptop or other computer**

If you want to connect to a PC laptop or Macintosh PowerBook, see page 12. To connect to a desktop computer or workstation, see Appendix A.

- **Connecting to video sources**

You can connect a DVD player, VCR, camcorder, laser disc player, digital camera, or any other video source to your projector. You can connect both computer and video sources at the same time and easily switch between them. See page 15 for instructions.

- **Using the remote control**

The remote control lets you switch from computer to video or EasyMP source, with access to picture-in-picture, pointer, zoom, and many other projector features. For details, see Chapter 3.

By connecting an additional cable, you can also use the remote control as a wireless mouse. This lets you click through computer-based presentations (such as PowerPoint) from up to 30 feet away. For more information, see page 38.

- **Including sound in your presentation**

If your presentation includes sound, you can connect an audio cable to use the projector’s built-in stereo speakers. For details, see page 14 (for laptops) or Appendix A (for other systems).

You can also connect external speakers or a public address system to the projector’s **Audio Out** port; see page 106.

Using Your Documentation

To connect the projector to your laptop and get your presentation running fast, see the *Quick Setup* sheet that came in your *Owner's Kit*.

This book contains all the information you need to set up and use your projector. Please follow these guidelines as you read through it:

- Warnings must be followed carefully to avoid bodily injury.
- Cautions must be observed to avoid damage to your equipment.
- Notes contain important information about your projector.

Reading This Manual Online

Your PowerLite 505c/715c CD-ROM includes an electronic copy of this manual. You may find it convenient to copy it onto your laptop's hard drive so it's always with you—for example, when taking your presentation on the road.

To view your electronic manual, you need to use Adobe® Acrobat® Reader. Just insert the PowerLite CD-ROM in your CD-ROM drive, select the **Install/View User's Guide** button and click **Install User's Guide** or **View User's Guide**.

When you open the manual, you see this toolbar:

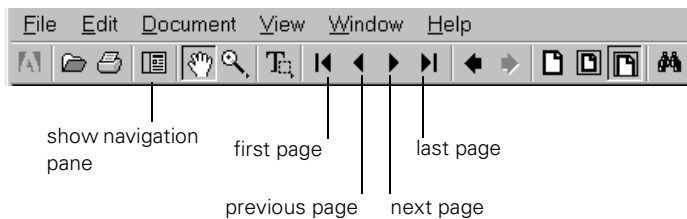

You have several ways to navigate through the manual:

- Click in the table of contents on the left side of the screen to move quickly to the topic of your choice.
- Use the arrow buttons in the toolbar or on the vertical scroll bar on the right side of the screen to move through the manual.

note

If you do not have Acrobat Reader, you can install it from the CD-ROM.

- If you hold your mouse pointer over text and the hand changes to an index finger, you can click to jump to a related topic.

For more information, see your Acrobat Reader online guide.

Getting More Information

Need tips on giving presentations? Quick steps for setting up your projector? Here's where you can look for help:

- **www.presentersonline.com**
Includes a library of articles covering presentation tips, tricks, and technology. The site provides templates, clip art and sound clips, as well as Presenters Services to use on the road. Even more resources and services are available if you register to join the Presenters Club®—and it's free.
- **Owner's Kit envelope**
Includes your *Quick Setup* sheet, warranty brochures, CD-ROMs, and EPSON PrivateLine® Support card. Store this *User's Guide* in the envelope and keep the envelope with your projector at all times.
- **Quick Setup sheet**
Gives you all the instructions you need to get your projector set up and connected to a laptop or PowerBook computer.
- **Built-in help system**
Provides assistance for common problems. Available from the Help button on the projector or the remote control. See page 90 for details.
- **support.epson.com**
Download FAQs and e-mail your questions to EPSON support.
- **CD-ROMs**
Your projector comes with two CD-ROMs. The PowerLite 505c/715c CD-ROM lets you register electronically and includes the electronic copy of this book as well as a link to *Presenters Online*. On the EasyMP CD-ROM, you'll find the software that you need to install on your computer to use the EasyMP features.

note

You don't need to install any software to use your projector with a computer. However, you need to install EasyMP if you want to present without a computer.

If you still need help after checking this *User's Guide* and the sources listed above, you can use the EPSON PrivateLine Support service to get help fast. Call (800) 637-7661 and enter the PIN on the card in your *Owner's Kit*. Or take advantage of EPSON's automated support services 24 hours a day. See page 103 for more information.

Registration and Warranty

Your projector comes with a basic carry-in warranty and an international warranty that let you project with confidence anywhere in the world. For details, see the warranty brochures included in your *Owner's Kit*.

In addition, for customers who register their projectors, EPSON offers free Extra CareSM Road Service. In the unlikely event of an equipment failure, you won't have to wait for your unit to be repaired. Instead, EPSON will ship you a replacement unit anywhere in the United States or Canada via overnight delivery. See the brochure in your *Owner's Kit* for details.

To register, simply insert the PowerLite 505c/715c CD-ROM that came with your projector and select **Register Online**. Registering also lets you receive special updates on new accessories, products, and services. You can register through the Internet, by e-mail or 800-number modem connection, or by printing out the form to fax or mail.

Unpacking the Projector

After unpacking the projector, make sure you have all the parts shown below:

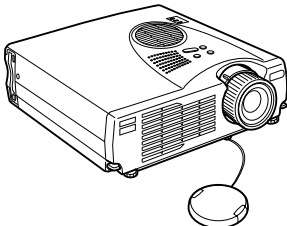

projector



remote control



EPSON PowerLite 505c/715c CD-ROM
(not needed to use your projector)



batteries

EasyMP CD-ROM
(for computer-free presentations)

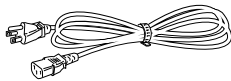

power cord



computer cable

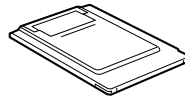

memory card set
(in the projector)

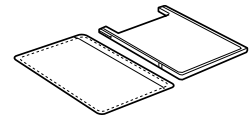

dummy card and case

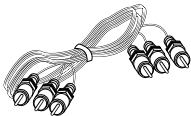

RCA AV cable

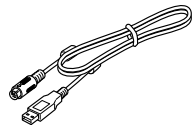

USB mouse cable

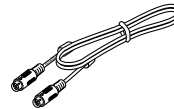

PS/2[®] mouse cable

Save all packaging in case you need to ship the projector. Always use the original packaging (or the equivalent) when you need to send the projector to another location.

If you are moving the projector by hand, use a carrying case (such as the optional cases available from EPSON). See page 8 for more information about cases.

Additional Components

Depending on how you plan to use the projector, you may need additional components:

- To transfer presentations directly to the memory card in the projector, you need a standard USB cable.
- To receive an S-Video signal, you need an S-Video cable. (One is usually provided with your video device.)
- To receive a component video signal from a VCR or other video device, you need a D-sub 15-pin to 3BNC component video cable (available from EPSON).
- To amplify your computer's audio through the projector's sound system, you need a computer audio cable (male-to-male 3.5-mm stereo miniplug cable). See your computer or electronics dealer to obtain this cable.
- Some older PowerBooks and Macintosh desktop models may need the Macintosh adapter set shown on page 111 (available from EPSON; see page 8). Older iMac systems may need a special adapter to provide a VGA output port; see your computer dealer.
- Some systems may need an additional cable to use the remote control as a wireless mouse. If your Macintosh doesn't have a USB port, you'll need a Macintosh mouse cable. See your projector dealer to obtain the correct cable.

Optional Accessories

To enhance your use of the projector, EPSON provides the following optional accessories:

Product	Product number
Replacement lamp and air filter	ELPLP14
Soft carrying cases: Samsonite® wheeled soft case Slimline soft shoulder bag Notebook/projector soft shoulder bag ATA molded hard shell case	ELPKS35 ELPKS31 ELPKS32 ELPKS30
Ceiling mount	ELPMB34
Suspension adapter for ceiling mount (1-inch pipe)	ELPMBAPS
Suspension adapter for ceiling mount (1.5-inch pipe)	ELPMBAST
Kensington MicroSaver® security lock	ELPSL01
Portable projection screens: 50-inch screen 60-inch Insta-Theatre screen 80-inch Insta-Theatre screen	ELPSC06 ELPSC07 ELPSC08
Wireless microphone and two satellite speakers	ELPCVS1
Presentation audio system	ELPPAS1
Macintosh adapter set (includes monitor adapter and desktop adapter)	ELPAP01
VGA to 13W3 video cable (for connecting to certain high-end workstations)	ELPKC06
Component video cable (D-sub 15-pin to 3BNC)	ELPKC19

You can purchase these accessories from your dealer or by calling EPSON at (800) 873-7766; or visit the EPSON Store™ at www.epson.com (U.S. sales only). In Canada, please call (800) 873-7766 for dealer referral.

1 *Setting Up the Projector*

This chapter tells you how to set up the projector and connect it to a laptop computer or video source. If you need to connect the projector to a desktop or workstation computer, see Appendix A.

Using the EasyMP feature, you can give a presentation directly from the projector, without connecting a computer. See Chapters 2 and 3 for information on using the computer and remote control. Then turn to Chapters 4 and 5 to learn how to use EasyMP.

You'll find instructions for the following in this chapter:

- Positioning the projector
- Connecting to a laptop computer
- Connecting to video sources

Positioning the Projector

Before connecting the projector, you need to decide where to place it. The location you choose depends on the size of the room and what you are projecting.

caution

Don't hold or lift the projector by the lens, or you may damage it.

note

It's easier to position the projector when the screen is directly in front of the room. If the screen is placed diagonally in a corner, it's much more difficult to aim the projector correctly at the screen and get a square image.

- Place the projector on a sturdy, level surface, between 3.6 and 45.5 feet from the screen.
- Make sure there is plenty of space for ventilation around and under the projector.
- Make sure the projector is within 6 feet of a grounded electrical outlet or extension cord. If you're using a computer and/or video source, locate them within 5 feet of your projector.
- Place the projector directly in front of the center of the screen, facing it toward the screen squarely. Otherwise, your image will not be square.

Most presenters find it convenient to place the projector in front of the audience, leaving as much space as possible between the projector and the screen to get a good-sized image. This lets the presenter stand in the front of the room, face the audience, and remain close enough to the equipment to be able to control it.

Use the figure below as a guideline to help you determine how far from the screen to place the projector. Image size generally increases with distance, but may vary depending on how you position the lens ring and whether you have adjusted the image size with other settings.

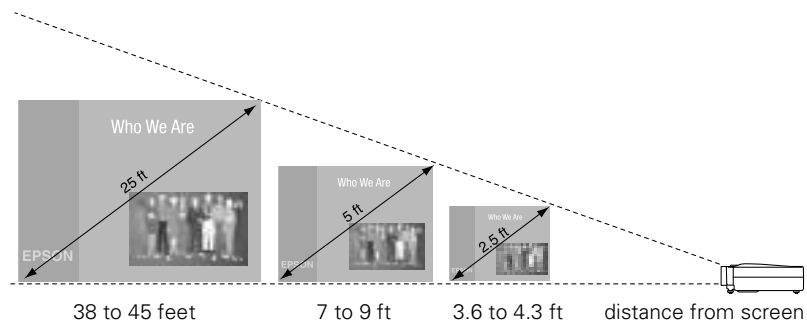

If you place the projector below the level of the screen, you'll have to tilt it up by extending the feet as shown. Tilting the projector upward causes the image to lose its square shape, but you can correct the distortion by pressing the **Keystone** button as described in the next chapter.

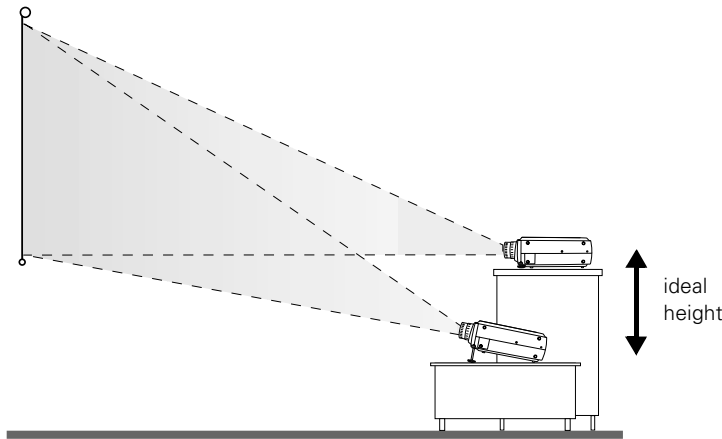

If you place the projector level with the bottom of the screen, the image will be square and you won't have to adjust it. If you place the projector higher than the bottom of the screen, the image will still be square, but you won't be able to fill the whole screen with the image.

If you're using the EasyMP system to give your presentation directly from the projector, you don't need to read the rest of this chapter. Once you have the projector positioned, you can plug it in and adjust the image, as described in Chapter 2.

- If a presentation is already saved on the memory card in your projector, you can run it as described in Chapter 5.
- If you need instructions for creating presentations that you can deliver without a computer, see Chapter 4.

note

After positioning the projector, you may want to connect a Kensington MicroSaver anti-theft device to the lock port on the projector's left side. You can purchase this from EPSON; see page 8.

Connecting to a Laptop Computer

note

To connect to desktops and other computer systems, see Appendix A. If you have an iBook with an RCA video-out port, follow the instructions for connecting to a video device on page 16.

You can connect the PowerLite projector to any computer that has a standard video output (monitor) port, including PC notebook and laptop computers, Macintosh PowerBooks, and hand-held devices.

Connecting the Computer Cable

Before you start, make sure your computer and the projector are turned off.

1. Connect one end of the computer cable to the projector's Computer port.

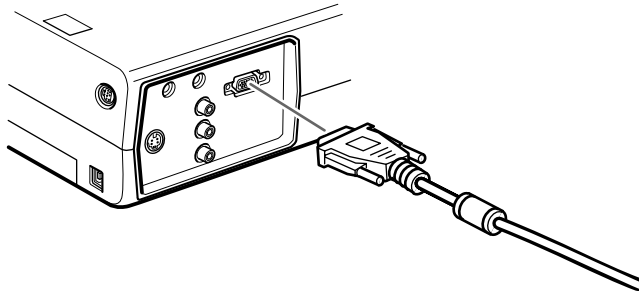

2. Connect the other end of the computer cable to your laptop's video-out or monitor port.

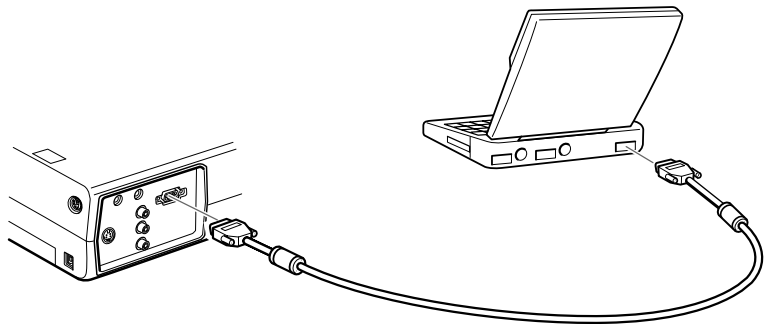

note

Laptop configurations vary. See your computer manual for the location of the ports needed to connect your projector.

If you're using a PowerBook and you can't connect the cable, you may need to use the Macintosh desktop adapter as shown on page 111 (available from EPSON; see page 8).

3. Tighten the screws on the connectors.

If you don't need to make any other connections, you can plug in your projector and turn it on. See page 20 for instructions.

Connecting the Cable for Remote Mouse Control

Using the remote control as a wireless mouse lets you click through slideshow-style presentations, such as PowerPoint, from up to 30 feet away (for details, see page 38). This gives you more flexibility in delivering your presentation, since you won't need to stand near your computer.

You'll use different cables and different ports on the projector, depending on whether your laptop has a round mouse port or a flat USB mouse port.

note

If you're using a PowerBook that has a round mouse port, you'll need a Macintosh mouse cable. See your projector dealer to obtain the correct cable.

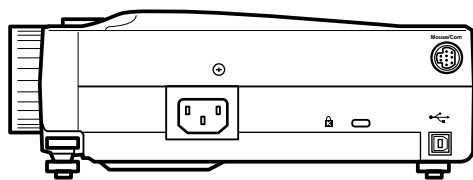

Mouse/Com port

USB port

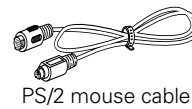

PS/2 mouse cable

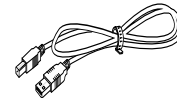

USB mouse cable

1. Locate the cable you need, depending on whether your laptop has a round PS/2 mouse port or a flat USB port.
2. Connect one end of the appropriate mouse cable to the projector's Mouse/Com port, as shown.

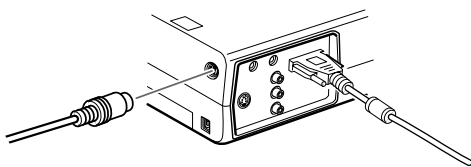

connecting PS/2 mouse cable

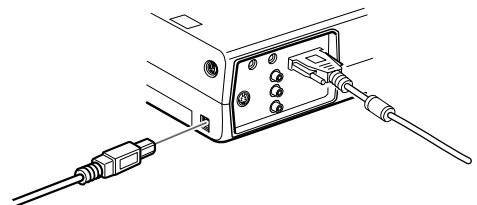

connecting USB mouse cable

3. Connect the other end of the cable to the external mouse port or USB port on your laptop.

4. If necessary, configure your laptop to work with an external mouse.



If you don't need to make any other connections, you can plug in your projector and turn it on. See page 20 for instructions.

Amplifying Computer Audio

Your laptop probably has its own sound system; however, it may not be adequate for your presentation. If you need more volume or better sound quality, you can connect a computer audio cable to take advantage of the projector's built-in amplifier and speaker. You can obtain a computer audio cable (3.5-mm stereo miniplug cable) from a computer or electronics dealer.

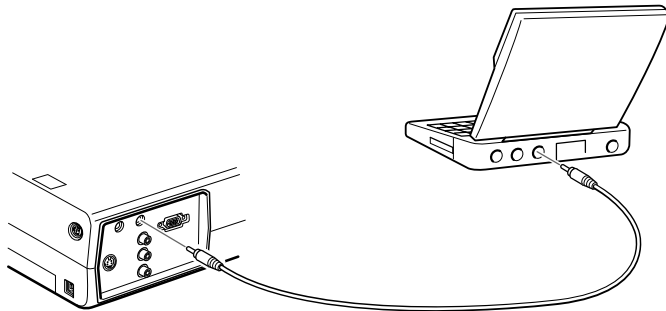
1. Connect one end of the audio cable to the **Audio In** jack on the projector.



2. Connect the other end of the audio cable to your laptop's  headphone jack or  audio-out jack. (Jack locations vary; see your computer manual if you're not sure of which jack to use.)

If you don't need to make any other connections, you can plug in your projector and turn it on. See page 20 for instructions.

Connecting to Video Sources

You can connect a DVD player, VCR, camcorder, laser disc player, digital camera, or any other compatible video source to your projector.

The projector supports HDTV, NTSC, PAL, and SECAM, and automatically detects the video format.

The projector can receive composite video, S-Video, and component video. You can connect the projector to one or two of these video sources at the same time; however, you can only use audio from one source at a time.

The type of cable you use depends on whether you have composite video, S-Video, or component video.

- For composite video, use the RCA AV cable included with the projector.
- For component video, you will need the optional EPSON component video cable (D-sub 15-pin to 3BNC, ELPKC19).
- For S-Video, use the S-Video cable supplied with your video device or obtain one from your electronics dealer.

See the following illustration if you're unsure of which type of connectors you have.

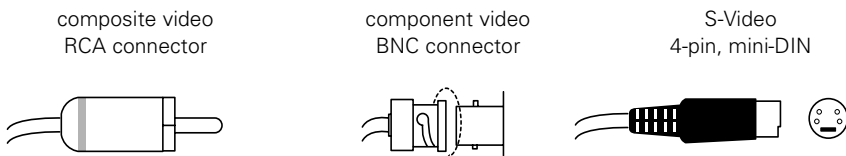

If more than one type of connector is available, S-video and component video provide higher quality than composite video.

Follow the instructions below for your type of connection.

note

The projector does not support TV antenna cable F connectors.

Connecting the RCA AV Cable

Before starting, make sure the projector and your DVD player or other video source are turned off.

1. Connect the yellow plug on one end of the AV cable to the projector's yellow **Video** jack.
2. Connect the other end of the cable to the video-out jack on your video source.

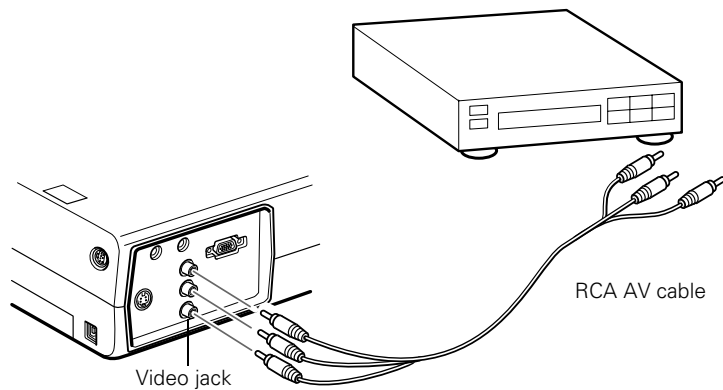

3. Connect the AV cable to the left and right Audio jacks on the projector (insert the white plug into the L port and the red plug into the R port).
4. Connect the plugs at the other end of the cable to the audio output jacks on your video source.

Connecting S-Video

If your video source has an S-Video jack, you can use it to project a higher quality video image. However, you'll need an S-Video cable, which may be included with your video source, or may be purchased.

Before starting, make sure the projector and your DVD player or other video source are turned off.

1. Insert one end of an S-Video cable into the projector's **S-Video** connector.
2. Insert the other end into the S-Video output port of your video source.

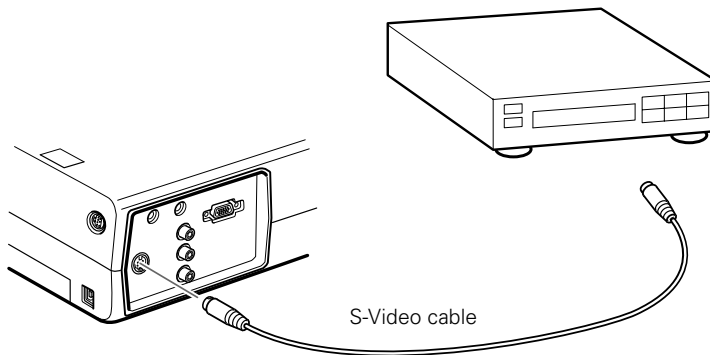

3. Connect the RCA AV cable to the left and right **Audio** jacks on the projector. (Match the red and white plugs to the red and white jacks; you won't need to use the yellow plug.)
4. Connect the plugs at the other end of the cable to the audio output jacks on your video source.

Connecting Component Video Cables

If your video source has component video connectors, you can use them to project a higher quality video image. However, you'll need a component video cable (D-sub 15-pin to 3BNC), which can be purchased from EPSON (ELPKC19).

Before starting, make sure the projector and your DVD player or other video device are turned off.

1. Connect the large end of the component video cable to the projector's **Computer/Component Video** port.
2. Insert the three ends of the component video cable into the **R**, **G**, and **B** ports on your video source.

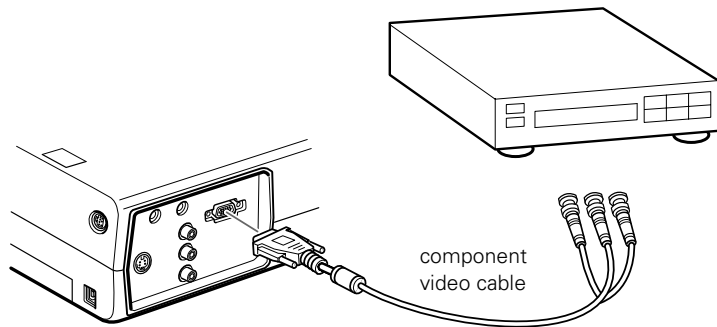

3. Connect the RCA AV cable to the left and right **Audio** jacks on the projector. (Match the red and white plugs to the red and white jacks; you won't need to use the yellow plug.)
4. Connect the plugs at the other end of the AV cable to the audio output jacks on your video source.
5. After you turn on the projector, use the Video menu to set the Input Signal to **YCbCr** or **YPbPr**. See page 74 for more information.

2

Using the Projector

Once you've set up the projector, you're ready to turn it on, adjust the image, and give your presentation. You can use the built-in EasyMP system to project without connecting to other equipment, as described in Chapter 5. Or, you can connect the projector to a computer or video source, as described in Chapter 1 and Appendix A.

Although you can operate the projector without it, the remote control lets you use additional features. See Chapter 3 for instructions on using the remote. This chapter covers the following:

- Turning on the projector and other equipment
- Adjusting the image
- Shutting down the projector

Turning On Your Equipment

Make sure your projector (and optional equipment) are set up and connected correctly, as described in Chapter 1 or Appendix A. Then turn on your projector, as described below, followed by any equipment you've connected to it. You can turn on your computer and video equipment in any order, but if you have both a computer and video source connected, you may have to switch to the desired source as described on page 23.

Turning On the Projector

Follow these steps to plug in and turn on the projector:

1. Connect one end of the power cord to the projector's power inlet.

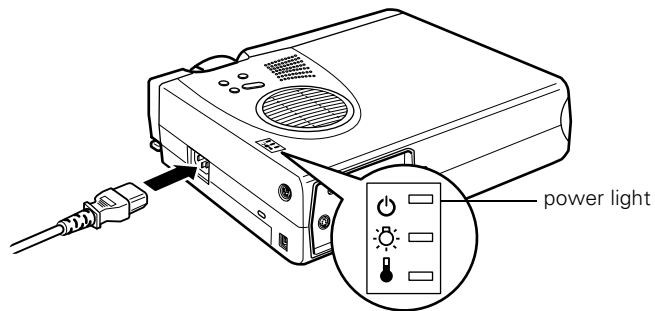

2. Connect the other end to a grounded electrical outlet.

The power light on top of the projector turns orange, indicating that the projector is receiving power but not yet turned on.

3. Use the tab on the lens ring to rotate the ring and extend the lens.

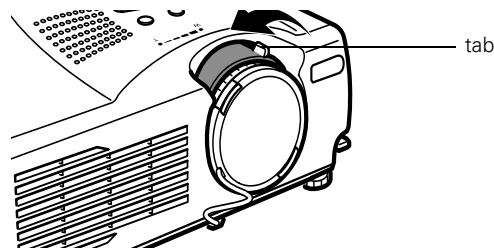

- Squeeze the lens cap tabs and remove the lens cap.

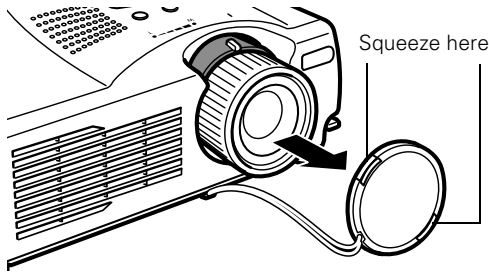

- Press the red Power button on top of the projector.

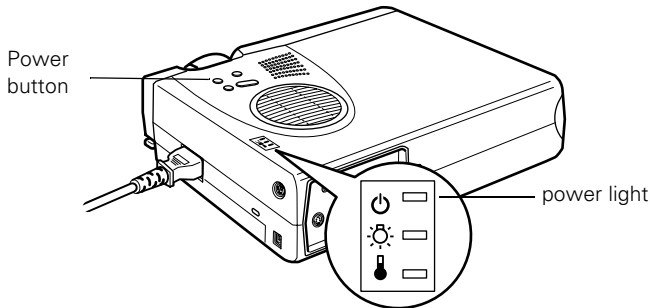

The power light flashes green as the projector warms up, and the projection lamp comes on in about 30 seconds. The power light stays green.

You may see the EasyMP main screen or a presentation that has been saved on the memory card and set to run automatically.

caution

Do not use the projector with the lens cap in place. The heat generated by the lens can damage the cap.

warning

Never look into the lens when the lamp is on. This can damage your eyes, and is especially dangerous for children.

6. Do one of the following:

- If you're presenting without a computer, you may see the EasyMP main screen. Use the **Enter** button on the remote control to select your presentation, then press **Enter** to start it. See Chapter 5 for more information.

If a presentation starts automatically, you may need to press **Enter** to change slides.

- If you're using a computer, turn it on or restart it. In a few moments, you should see your computer display projected. If you see an EasyMP screen or presentation instead, press the **Source** button on top of the projector to switch to the computer.

(Windows[®] only: If you see a message saying that it has found a plug-and-play monitor, click **Cancel**.)

- If you're projecting a video, press the **Source** button on top of the projector to switch to your video source, and press the **Play** button on your DVD player or other device.

If a projected image fails to appear, see the next section for help.

Once you see your image, turn to page 24 for instructions on focusing and making other image adjustments.

When you're done with your presentation, shut down the projector as described on page 27. Shutting down the projector correctly prevents premature lamp failure and possible damage from overheating.

What To Do If You See a Blank Screen

If you see a blank screen or a blue screen with the message **No Signal** after turning on your computer or video source, try the following:

- Make sure the cables are connected correctly, as described on page 12 (for laptops) or in Appendix A (for other systems).
- Make sure the power light is green and not flashing and the lens cover is off.
- Try restarting your computer.

- Press the **Source** button on top of the projector to select the correct source. (Allow a few seconds for the projector to sync up after pressing the button.)

If you're using a PowerBook:

You may need to set up your system to display on the projector screen as well as the LCD screen. Follow these steps:

1. From the Apple menu, select **Control Panels**, then click **Monitors and Sound**.
2. Click the **Arrange** icon.

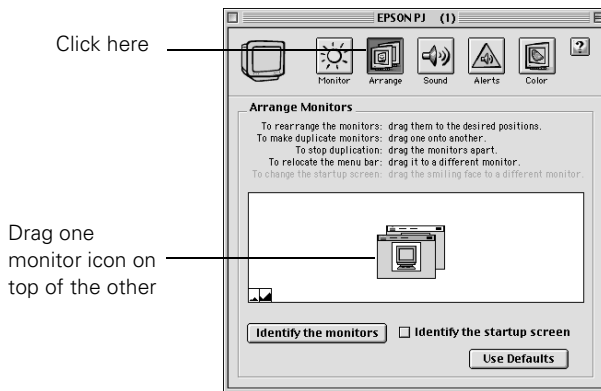

3. Drag one monitor icon on top of the other.

If this option isn't available, you may need to select one of the Simulscan resolution settings:

1. Click the **Monitor** icon.

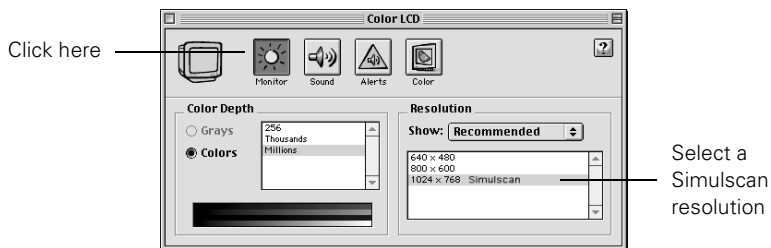

2. Select a **Simulscan** resolution as shown. (Allow a few seconds for the projector to sync up after making the selection.)

If you're using a PC laptop:

- Hold down the Fn key and press the function key that lets you display on an external monitor. It may have an icon such as  or it may be labelled CRT/LCD. Allow a few seconds for the projector to sync up after pressing it. Check your laptop's manual or online help for details.

On most systems, the  key lets you toggle between the LCD screen and the projector, or display on both at the same time.

- Depending on your computer's video card, you might need to use the Display utility in the Control Panel to make sure that both the LCD screen and external monitor port are enabled. See your computer's documentation or online help for details.

Adjusting the Image

Once you see your image, you'll need to make certain adjustments:

- To focus or zoom your image, see page 25.
- If the image is too high or too low, you can reposition it. See page 25.
- If the image isn't square, see page 26.
- If the projected image colors are obviously incorrect, you may need to adjust the **Input Signal** setting on the Video menu. See page 74 for more information.

Focusing and Zooming Your Image

Rotate the focus ring to sharpen the image.

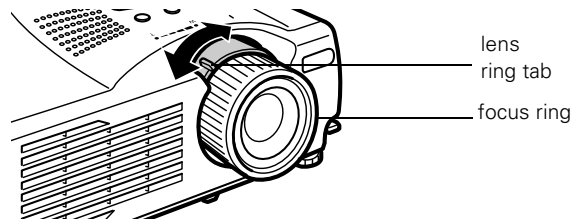

Use the tab to rotate the lens ring and reduce or enlarge the image.

You can also change the image size by moving the projector closer to or farther away from the screen. You can use the **E-ZOOM** button on the remote control to zoom in on a portion of the image. See page 33 for instructions.

Adjusting the Height of Your Image

If the image is too low, you can raise it by extending the projector's feet.

1. Stand behind the projector. Pull up the blue foot release levers and lift the front of the projector. This unlocks the feet.

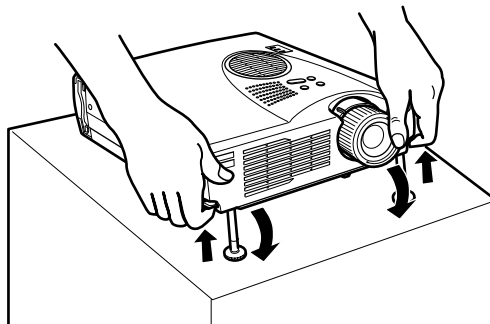

2. Once the image is positioned where you want it, release the levers to lock the feet in position.
3. To fine-tune the height of the image, rotate the thumb wheels attached to the projector's feet.





If the image is no longer square after raising it, see the next section.

caution

Do not hold the projector by the lens; this can damage it.

Adjusting the Image Shape

If the projected image isn't square or has a "keystone" shape, do one or more of the following:

- If your image looks like  or , you've placed the projector off to one side of the screen, at an angle. Move it directly in front of the center of the screen, facing the screen squarely.
- If your image looks like  or , press the + or — side of the **Keystone** button to correct the shape of the image. After correction, your image will be slightly smaller.

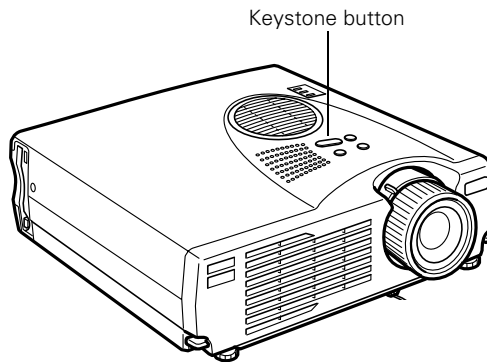

You can also perform electronic keystone correction using the projector's Setting menu. See page 79.

Shutting Down the Projector

When you've finished using the projector, follow the recommended procedure to shut it down. This extends the life of the lamp and protects the projector from possible overheating.

1. If you're using a computer, shut it down first.
2. To turn off the projector, press the red **Power** button on the projector or remote control. You see a confirmation message. (If you don't want to turn it off, press any other button.)

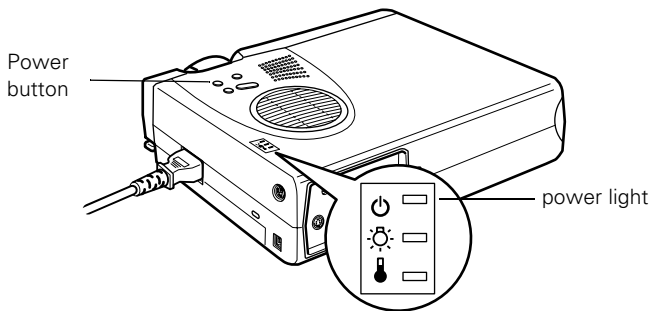

3. Press the **Power** button again. The power light flashes orange for about a minute as the projector cools down. When the projector has cooled, the orange light stays on and the exhaust fan shuts off.

If you want to turn the projector on again, wait until the orange light stops flashing. Then press the **Power** button.

4. Replace the lens cap, retract the lens, and unplug the power cord.
5. If you're using a VCR or other video source, turn it off after you turn off the projector.
6. Disconnect all equipment, and store the projector in the bag that came with it or in a protective case.

note

*When the projector has not received any input signals for 30 minutes, it automatically turns off the projector lamp and enters "sleep mode." This conserves electricity, cools the projector, and extends the life of the lamp. If you are done using the projector, unplug the power cord. If you want to start projecting again, press the **Power** button.*

caution

To avoid damaging the projector or lamp, never unplug the power cord when the power light is green or flashing orange.

3 *Using the Remote Control*

The remote control lets you access your projector's features from anywhere in the room—up to 30 feet away. You can use it to turn the projector on and off, zoom in on a portion of your image, and highlight your presentation.

You can also use the remote control for EasyMP presentations without a computer. See Chapter 5 for more information about EasyMP.

If you're using a computer and you've connected the mouse cable (as described in Chapter 1 or Appendix A), you can use the remote control as a wireless mouse.

This chapter covers the following information:

- Turning on and using the remote control
- Controlling the picture and sound
- Highlighting your presentation
- Using the remote control as a wireless mouse

Turning On and Using the Remote Control

caution

When replacing batteries, take the following precautions:

- Don't mix old and new batteries.
- Replace batteries as soon as they run out. If the batteries leak, wipe away battery fluid with a soft cloth. If fluid gets on your hands, wash them immediately.
- Do not expose batteries to heat or flame.
- Dispose of used batteries according to local regulations.
- Remove batteries if you won't be using the projector for a long period of time.

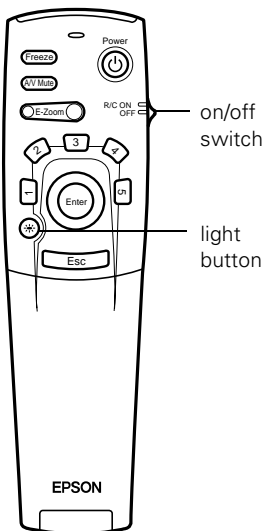

Before using the remote control, you need to install its batteries and turn it on as described below.

Installing Batteries

Follow these steps to install or replace the batteries:

1. Press the tab to release the battery compartment cover.
2. Remove the cover and insert the two AA batteries included with the projector as shown.
3. Replace the battery compartment cover.

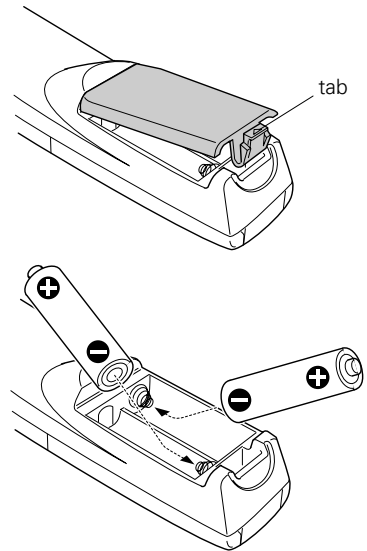

Turning On the Remote Control

Make sure batteries are installed. Then push up the on/off switch on the side of the remote control to turn it on.

If you want to make sure the batteries are good, press the round  light button. The other buttons on the remote should light up temporarily. If they don't, you need to change the batteries as described above.

Turn off the remote control before transporting it or storing it in a projector case. This prevents the batteries from discharging if something presses against one of the buttons.

Using the Remote Control

When using the remote control, stand within 30 feet of the projector. Point the remote control either at the front or back of the projector or at the screen (the projector's front sensor can detect signals bounced off the screen).

- Press the button for the function you want to use. See the following pages for instructions.
- For some functions, you need to use the **Enter** button like a mouse to navigate on the screen. Press the edge of the button with your thumb—or grasp it between your thumb and finger and tilt it in the direction you want to move.
- To access additional buttons, pull down the cover below the **Esc** button, as shown below:

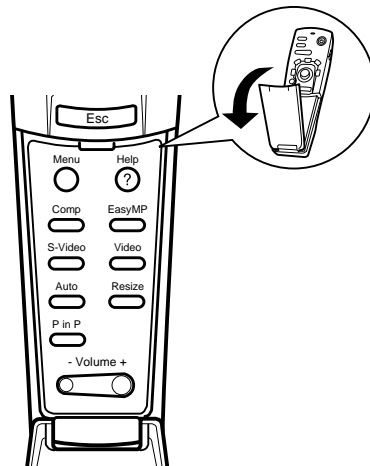

Controlling the Picture and Sound

You can use the remote control to select your source, adjust the volume, temporarily turn off the picture and sound, freeze the action, zoom in on the picture, or display a picture-in-picture video image. Make sure you have set up your projector and connected any equipment as described in Chapter 1 or Appendix A.

Switching Between Picture Sources

If you've connected your projector to a computer and/or video sources, you can use the buttons on the remote control to switch between the different sources.

- Press the **Comp** button to select your computer source.
- Press the **EasyMP** button to select EasyMP (for presentations stored on the memory card).
- Press the **Video** button to select a standard composite video source.
- Press the **S-Video** button to select an S-video source.

After you select a source, the screen goes dark for a moment before the image appears.

Adjusting the Volume

If you've connected an audio source to the projector, you can adjust the sound that's output through the projector's speakers.

- To increase the volume, press on the right (+) side of the **Volume** button.
- To reduce the volume, press on the left (-) side of the **Volume** button.

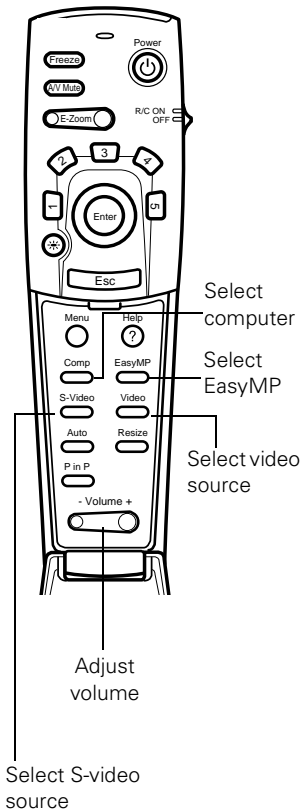

Turning Off the Picture and Sound

You can use the A/V Mute button on the remote control to turn off the image and sound and darken your screen. This is useful if you want to temporarily re-direct your audience's attention without the distraction of a bright screen.

- To turn off the picture, press the A/V Mute button. The screen goes dark.
- To turn the image back on, press the button again.

Stopping Action

You can use the remote control to stop the action in your video or computer image.

- Press the Freeze button to stop the action and keep the current image on the screen. The sound will continue.
- Press the Freeze button again to re-start it.

Zooming Your Image

You can zoom in on a portion of the image using the E-Zoom button on the remote control.

1. Press the right side of the E-Zoom button to zoom in on your image.
 - Press the button repeatedly to enlarge it up to four times in 24 steps.
 - Press and hold the button to zoom in to the size you want.
2. Use the Enter button to pan around the screen if necessary.
3. Press the left side of the E-Zoom button to zoom out. You can press the button repeatedly, or press and hold to zoom all the way out. You can also press the Resize button to return to the original size.

note

You can also have an image, such as a company logo, display on the screen whenever you press the A/V Mute button. See page 77 for instructions.

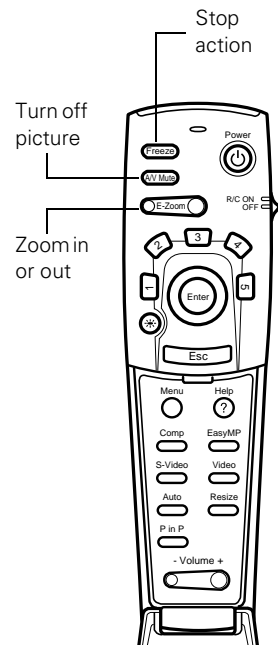

Resizing the Image

Some computer images need to be resized to display in the projector's native format—1024 × 768 pixels (PowerLite 715c) or 800 × 600 pixels (PowerLite 505c). If only part of your computer image is displayed, you can correct it with the **Resize** button.

- Press the **Resize** button on the remote control. The screen image is automatically compressed.
- Continue pressing the **Resize** button to pan around the screen in the original resolution.

If you're projecting from video equipment, pressing the **Resize** button switches the aspect ratio between 4:3 and 16:9. If you've zoomed in on your image (using the **E-ZOOM** button on the remote), you can press the **Resize** button to return it to the original display size.

Displaying Picture-in-Picture Video

You can open a small video window on your computer image, and view a video at the same time as your computer presentation.

First make sure you have connected your VCR or other video source using an RCA or S-Video cable as described in Chapter 1. If you're using S-Video, you need to select it in the **P in P** menu option as described on page 79.

1. Press the **P in P** button on the remote control. The screen may go dark for a moment, and then your video image appears in a small window on the screen. A menu appears in the lower left corner of the screen, describing how to move and resize the image.
2. Use the **Enter** button to reposition the video window on the screen. You can use the **E-ZOOM** button to enlarge or reduce the video window.

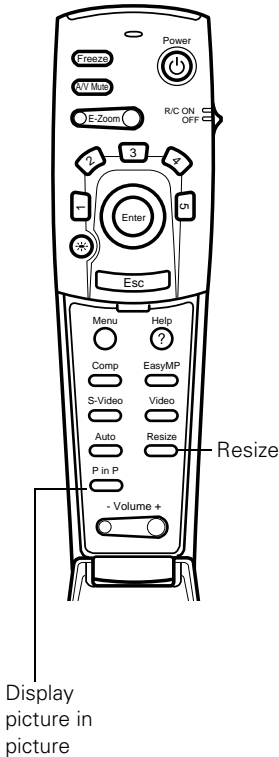

- When the window is located and sized the way you want, press the **Enter** button. The menu disappears, and your video plays on the screen.



- When you're finished viewing the picture-in-picture, press the **P in P** button again. The video window disappears.

Highlighting Your Presentation

You can highlight areas on the screen using the numbered buttons on the remote control. You can use these “special effects” features to annotate your presentation slides or call attention to your most important points. Five highlighting tools are available:

- Pointer or cursor stamp (button 1)
- Box (button 2)
- Spotlight (button 3)
- Bar (button 4)
- Erase (button 5)

You can customize the highlighting tools through the Effect menu. See page 75 for instructions.

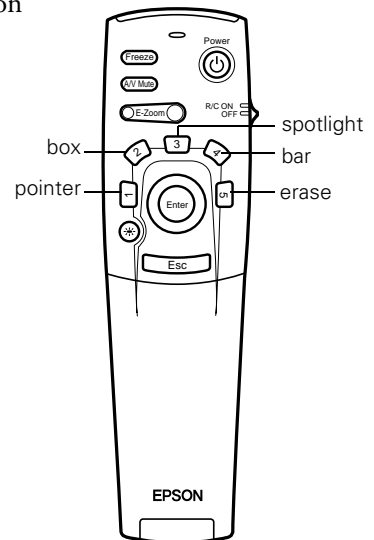

note

You can use the projector's Effect menu to select a different pointer. See page 75.

Using the Pointer

You can use the pointer tool to place an arrow anywhere on your screen.

1. To activate the pointer tool, press button 1 on the remote control. A  green pointer appears in the upper left corner of the screen.
2. Use the **Enter** button to move the pointer where you want it.
3. To “paste” the pointer on the screen, press down in the center of the **Enter** button. You can then continue to work with another pointer, moving it around the screen or pasting it wherever you want.
4. To erase the pointers pasted on the screen, press button 5.
5. To cancel the pointer feature, press **Esc**.

Using Box Highlights

You can draw outline boxes on the screen to highlight areas of your presentation or video.

1. To activate the box tool, press button 2 on the remote control. A  green square appears in the upper left corner of the screen. This is the box-drawing tool.
2. Use the **Enter** button to place the square where you want to begin drawing the box.
3. Press down in the center of the **Enter** button. You see a corner mark on the screen; this defines one corner of the box.
4. Use the **Enter** button to drag the square to where you want the opposite corner of the box to be.
5. Press down in the center of the **Enter** button. You see the box outlined on the screen.

You can continue placing boxes on the screen by repeating steps 2 through 5.

6. To erase the box(es), press button 5.
7. To cancel the box drawing feature, press **Esc**.

note

You can use the projector's Effect menu to change the color and shape of the box. See page 75.

Spotlighting Your Image

With the Spotlight tool, you can place a square highlight on part of the screen image.

1. To activate the spotlight tool, press button **3** on the remote control. The screen darkens, and a box of light appears on part of the image.
2. Use the **Enter** button to move the spotlight where you want it.
3. To remove the spotlight, press **Esc**.

You can change the size of the Spotlight using the Effect menu; see page 75.

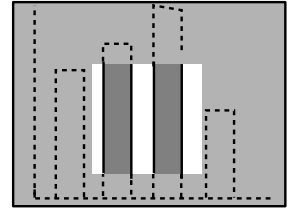

Using Horizontal and Vertical Highlights

With the bar tool, you can draw bold horizontal lines on the screen to underline or highlight your presentation points.

1. To activate the bar tool, press button **4** on the remote control. A horizontal bar appears across the screen.
2. Use the **Enter** button to move the bar up and down the screen.
3. To cancel the bar drawing feature, press **Esc**.

note

You can change the color and width of the bar—and change it from horizontal to vertical—using the Effect menu. See page 75.

Using the Remote Control as a Wireless Mouse

When you use the remote control as a wireless mouse, you can control your computer or click through slideshow-style presentations (such as PowerPoint) from up to 30 feet away. This gives you more flexibility, since you won't need to stand near your computer to change slides, for example.

With EasyMP, you can use the remote control to play back and edit presentations on the projector's memory card. See Chapter 5 for more information.

To control your computer with the remote, make sure you have connected the mouse cable between the projector and your computer as described on page 13 (for laptops) or in Appendix A (for other systems).

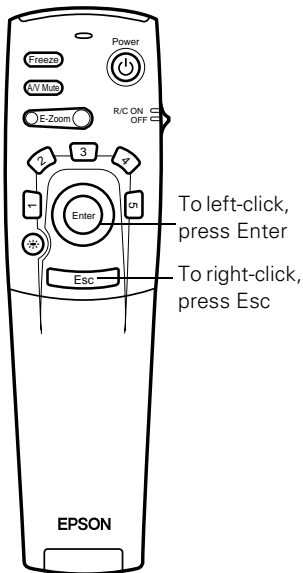

- To move the mouse pointer on the screen, aim the remote at the screen and press on the edge of the **Enter** button with your thumb—or grasp it between your thumb and finger and tilt it in the direction you want to move. This button works like the mouse button on many laptop keyboards.
- To click (or left-click), press down on the center of the **Enter** button. This changes slides in a PowerPoint presentation (in Slide Show mode) or in an EasyMP scenario.
- To right-click, press the **Esc** button.
- To double-click, press down twice on the **Enter** button.
- To click and drag, press down on the **Enter** button and then tilt it in the direction you want to drag.

4

Creating Presentations for Your Projector

The projector's EasyMP feature lets you give a presentation without a computer. Once you install the software, you can drag and drop a PowerPoint file to convert it into a format called a *scenario*. Then you can download the scenario to the projector's memory card and run it automatically or with the remote control.

Or, you can create a scenario from scratch by combining PowerPoint slides and images using the EMP SlideMaker software on your computer. You can start with any combination of existing PowerPoint slides, JPG image files, or BMP graphics files.

This chapter includes instructions for the following:

- Accessing the memory card
- Installing EasyMP
- Creating a scenario
- Transferring your presentation to the projector

Accessing the Memory Card

To access the memory card, you can either transfer it to your computer or use a USB cable to access the card in the projector. Use the instructions to do one of the following:

- Remove the memory card from the projector and insert it in your computer's PCMCIA slot or PC card reader.
- Use a USB cable to connect your computer to the projector and install the driver. This lets you transfer your presentation directly to the memory card in the projector. (Available with Windows 98/Me/2000 only.)

Moving the Memory Card from the Projector to Your Computer

If your laptop or desktop computer has a PCMCIA slot or PC card reader, you can insert the projector's memory card in your computer to transfer your scenario. First you need to remove it from the projector. Make sure a scenario is not playing and the card is not in use (the access light is off) before you remove it.

1. Press the button below the card slot.

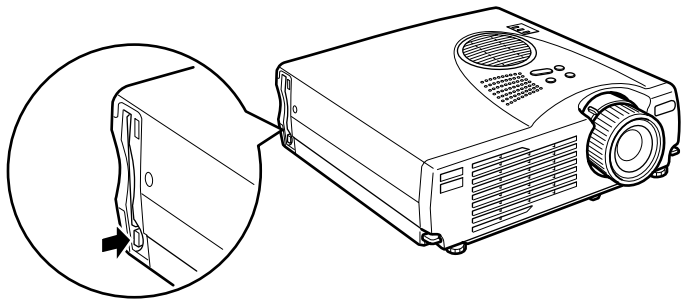

The button pops out.

2. Press the button again. The memory card is released, and you can remove it from the slot in the projector.

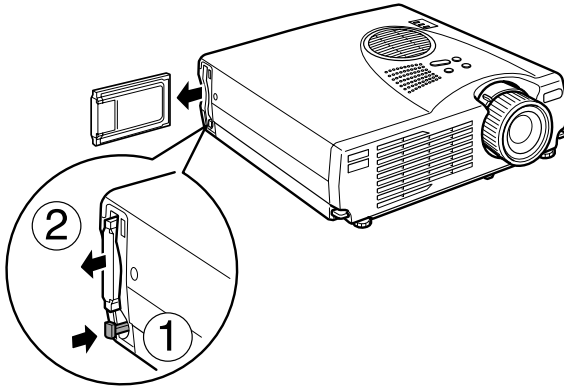

caution

Press the button carefully to avoid breaking it. Make sure the button is pressed in before you store the projector in a carrying case or box.

3. Press the button to insert it in the slot.
4. Insert the card in your computer's PCMCIA slot or card reader. See your computer documentation if you need instructions.

Continue with the steps on page 43 to install EasyMP so you can create a scenario and transfer it to the card.

If you need additional memory cards, you can use any of the following standard type II memory cards. Most require a PC card adapter:

- CompactFlash™
- Memory Stick™
- SmartMedia™
- Microdrive™
- ATA flash (does not require a PC card adapter)

If you need to remove the memory card from the adapter, simply pull it out as shown:

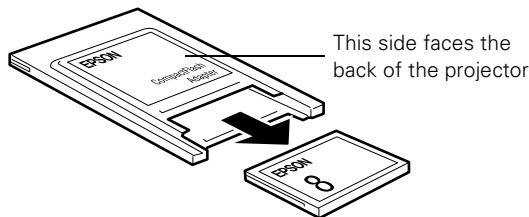

Accessing the Memory Card Through a USB Cable

If your computer has a USB port (and a factory-installed version of Windows 98/Me/2000), you can transfer your scenario to the memory card in the projector. This method is especially useful if you don't have a PCMCIA slot or PC card reader in your computer.



You'll need a shielded USB "AB" interface cable, available from any computer dealer. Before you can transfer your scenario, you need to install the USB driver from the EasyMP CD-ROM.

note

When your computer and projector are connected by USB cable, you may be able to use the remote control as a wireless mouse. See page 38 for more information.

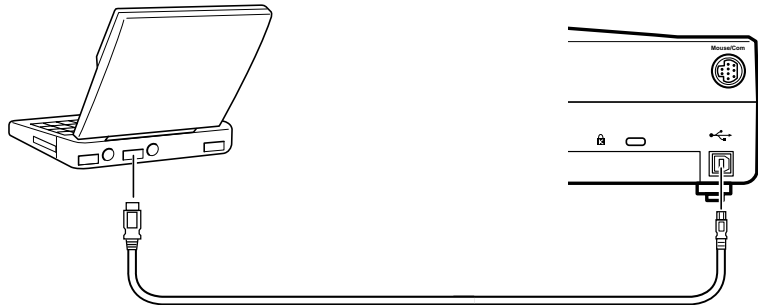
1. Connect the square end of the USB cable to the USB port on the side of the projector. Connect the flat end to your computer's USB port.



2. Plug in and turn on the projector and the computer. You see the **Add New Hardware** window on your screen.
3. Click **Cancel**. (If you're using Windows 2000, click **Next** and follow the instructions on the screen to install the USB driver.)
4. Insert the EasyMP Software CD-ROM in your drive.
5. Double-click  **My Computer**, then double-click the  **EasyMP** icon.
6. Double-click each of these folders to open them:
USB-Driver\Win98\Eng\Disk1
7. Double-click **Setup.exe** and follow the instructions on the screen to install the USB driver. When the installation is finished, click **Yes** to restart your computer, then click **Finish**.

Installing EasyMP

You must install the software to use the EasyMP features. Before you install EasyMP, make sure the computer you use meets the requirements listed below:



System Requirements

- IBM® compatible with at least a Pentium® 166 MHz processor (Pentium II 300 MHz or higher recommended)
- Microsoft® Windows 95/98/Me, Windows NT 4.0, or Windows 2000 (USB feature not available with Windows 95 or Windows NT 4.0)
- At least 32MB of RAM (96MB or more recommended)
- At least 12MB of free hard disk space
- VGA (640 × 480) or better display adapter and monitor

Installing the Software

Locate the EasyMP Software CD-ROM that came with your projector and follow these steps to install the software.

1. Insert the EasyMP Software CD-ROM in your drive. The setup program starts automatically.

If it doesn't start automatically, double-click  My Computer, double-click the  EasyMP icon, then double-click  setup.exe.

2. Select your language and click OK.
3. Follow the instructions on the screen to accept the license agreement and install the software.
4. When you see the Setup Complete message, click Yes to restart your computer, then click Finish.

Once EasyMP is installed, you see the  EMP SlideMaker icon on your desktop.

Creating a Scenario

A scenario is a series of slides and/or images that you can present without a computer. The easiest way to create a scenario is to drag and drop a PowerPoint file on the  EMP SlideMaker icon on your desktop. The file is converted automatically, and you can download it to the projector.

You can also create a scenario from scratch using the EMP SlideMaker software to combine PowerPoint slides and images. No matter how you start, you can enhance your presentation by adding transitions and other features.

Creating a Scenario by Drag and Drop

The drag and drop method is the easiest way to create a scenario. Use this method if you have an existing PowerPoint presentation that you want to transfer to the projector.

1. Locate the PowerPoint file you want to use in My Computer or the Windows Explorer.
2. Make sure the EMP SlideMaker program is closed. Then drag the file icon on top of the  EMP SlideMaker icon.

EMP SlideMaker starts, and PowerPoint opens briefly. You see the window shown at the left as each slide is converted.

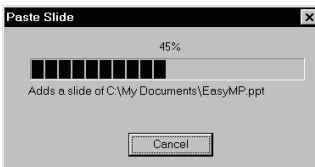

When the conversion is complete, you see your scenario in the EMP SlideMaker window:

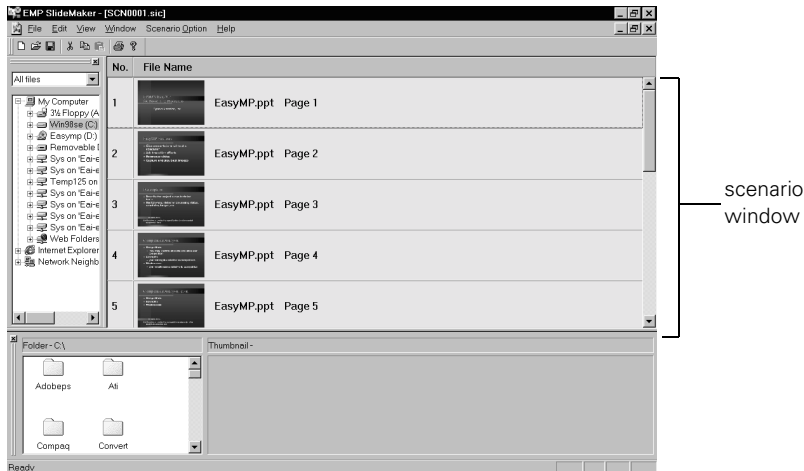

At this point, you can insert additional slides or images, create transition effects between slides, and add other features to your presentation. See page 47 for instructions.

3. Click the **Save** button or choose **Save** from the File menu.

EMP SlideMaker automatically names your scenario **SCN0001.sic** and creates a folder for it within your **\Program Files\EMP SlideMaker** folder. However, you can choose **Save As** from the File menu and enter a new scenario name and folder location if you want.

Once your scenario is saved, you can transfer it to the memory card, either in your computer's PCMCIA slot or in the projector. See page 52 for instructions.

Creating a New Scenario File

Use this method when you want to combine slides from several PowerPoint presentations and/or include additional images in your scenario. Make sure the EasyMP software is installed before you start.

1. To start the software, double-click the  EMP SlideMaker icon on your computer's desktop. You see the EMP SlideMaker screen:

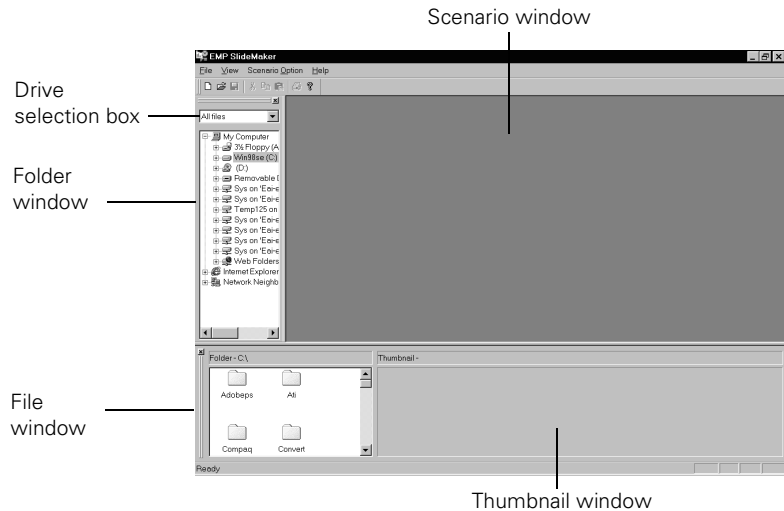

2. Choose **New** from the File menu. You see the Scenario Settings box:

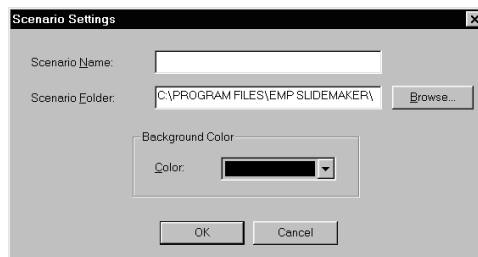

3. Type a name for your scenario. SlideMaker automatically creates a folder with the same name.
 - The default location for the scenario file and folder is in the \Program Files\EMP SlideMaker folder, but you can choose a new location.
 - The background color (black) appears around images that don't fill the entire screen area. You can choose a new color.
4. Click OK when you're finished with Scenario Setup.

Continue with the instructions in the next section to add slides and build your scenario.

Building a Scenario

Once a scenario file is created, you can build it by adding existing slides and images. You can add the following three types of files:

- PowerPoint slides, version 97 (SR-1 or higher) or 2000
- JPEG files (file names with .JPG extension)
- Bitmap files (file names with .BMP or .DIB extension)

Follow these steps to build a scenario:

1. Use the Drive selection box and Folder window to locate files that you want to include in your scenario.

PowerPoint, JPG, and BMP files appear as icons in the File window, as shown to the right.

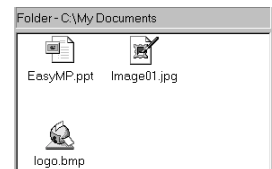

2. Drag and drop the files you want to use into the Scenario window.

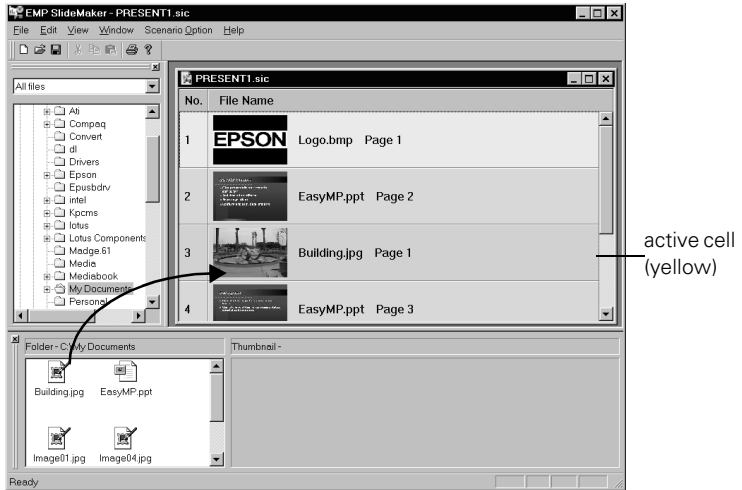

3. To include individual PowerPoint slides, click the PowerPoint file icon. PowerPoint opens briefly in the background, and the PowerPoint slides appear in the Thumbnail window.

Drag the slides from the Thumbnail window:

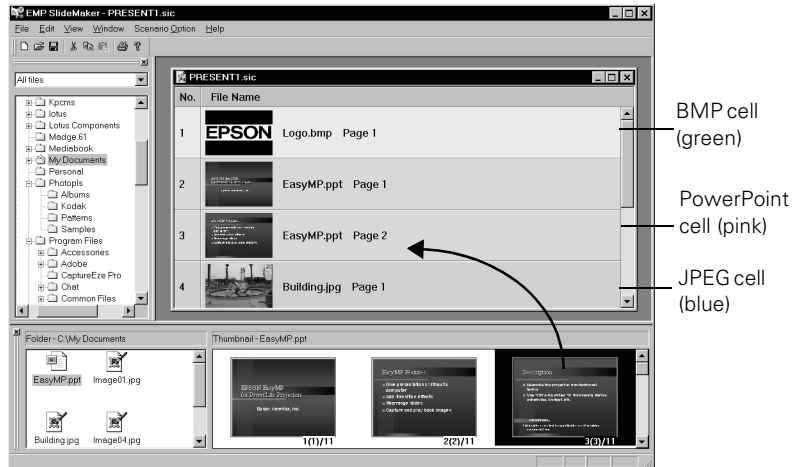

Each slide appears in a numbered “cell” in the Scenario window as you drop it. The cell background color varies according to the type of file in the cell.

If you need to rearrange cells, you can drag and drop them as necessary within the Scenario window.

When you have finished adding slides and images to your scenario, you can add transitions and other display settings. See the next sections for instructions.

Setting Up Transitions

EMP SlideMaker lets you set your slides to advance manually or automatically after a specified period of time. You can also choose from a wide variety of transition effects between slides or cells.

1. Click the cell you want to set up in the Scenario window.

To select more than one slide, hold down the **Ctrl** key while you click. To select all the cells, choose **Select All** from the Edit menu. Selected cells turn yellow.

2. Right-click the selected cell or cells. The Cell menu appears:

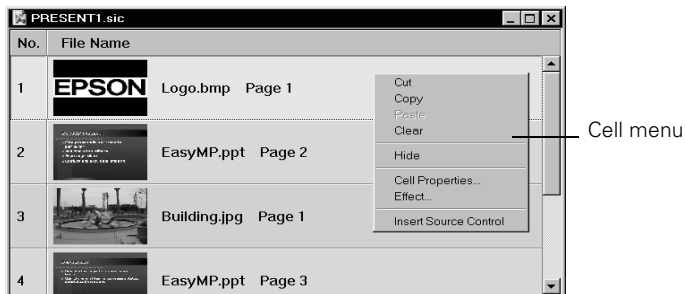

3. Click Cell Properties. The Cell Settings box appears:

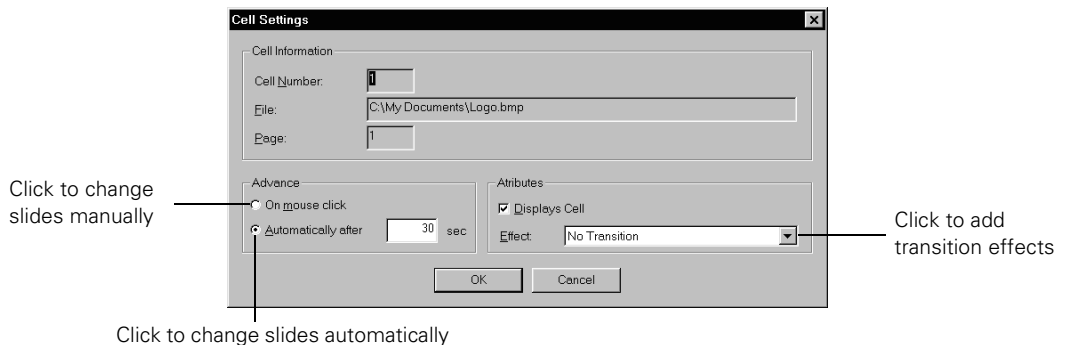

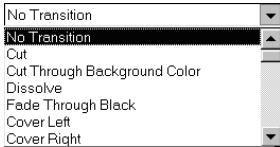

4. Choose how you want to advance to the next cell.
 - If you want to advance manually, click **On mouse click**.
 - If you want to advance automatically, set the timing in the **Automatically after** box. You can set any length of time between 1 and 1800 seconds (30 minutes).
5. To add a transition “special effect,” click the Effect box and choose from the list.
6. When you’re finished setting up the transition for the selected cell or cells, click **OK**.
7. Repeat steps 1 through 6 as necessary.
8. Click the **Save** button or choose **Save** from the File menu.

If you want to include computer access or video in your scenario, continue with the steps in the next section. If you’re ready to transfer your scenario to the projector, see page 52.

Adding Computer Access or Video

Adding computer access or video to your scenario lets you easily switch sources in the middle of your presentation. You can set up your scenario to switch manually or automatically and specify the length of time before switching back to your presentation. For example, you can have a video play for up to 30 minutes within your scenario.

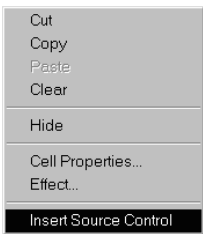

1. Right-click in the Scenario window where you want to switch sources (on the cell you want to follow the source switch). You see the Cell menu, as shown at the left.
2. Choose **Insert Source Control**. A Control cell appears in your scenario:

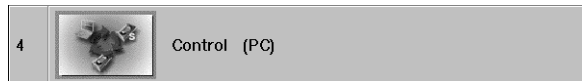

The cell is initially set to PC (computer access). This means that your scenario will access a computer connected to the projector at the point where the cell occurs. However, you can change the source to video, as described in the following step.

3. Right-click the control cell and choose **Cell Properties** from the menu. The Source Control box appears:

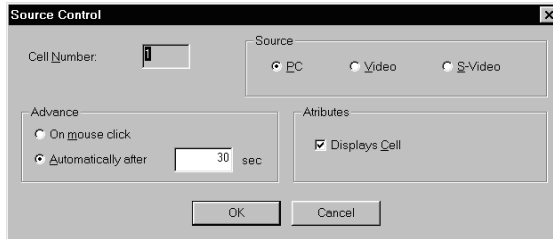

4. Select your source:
 - If you want to switch to video rather than a computer source, click **Video**.
 - If you plan to use the S-video connection for the DVD or other source, click **S-Video**.
5. Choose how you want to advance to the next cell.
 - If you want to advance manually, click **On mouse click**.
 - If you want to advance automatically, set the timing in the **Automatically after** box. You can set any length of time between 1 and 1800 seconds (30 minutes).
6. When you're finished setting up the source control cell, click **OK**.
7. To choose how you want to advance to the source control cell, right-click the previous cell, and choose **Cell Properties** from the menu. Set up the Advance properties as described on page 50.
8. When you're finished creating your scenario, click the **Save** button or choose **Save** from the File menu.

Once your scenario is saved, follow the instructions in the next section to transfer it to the memory card.

Transferring Your Presentation to the Projector

Once your scenario is saved, you can transfer it to the memory card. The transfer process converts your scenario from a .SIC file to a .SIT file. Only .SIT files can be played on the projector.

note

The USB connection is only available on computers with a factory-installed version of Windows 98, Me, or 2000. It is not available with Windows 95 or NT 4.0, and might not work on upgraded systems.

Before you start, make sure you are set up to access the card—either in your computer's PCMCIA slot or card reader, or through a USB connection to the projector. See page 40 for instructions on accessing the memory card.

1. From the Scenario Option menu, choose **Transfer Scenario**. You see a drive selection window:



Click to select your memory card drive

2. Choose the drive where your card is located—either in your computer's PCMCIA slot or card reader, or in the projector.
3. Click OK. You see a confirmation message.
4. Click OK again. You see a window that displays the progress of your scenario.

After the scenario has been transferred to the card, you see the following message about your scenario's Autorun setting:

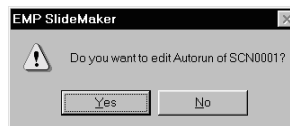

The Autorun setting means that the scenario will start playing whenever the projector is turned on (with the memory card in the projector).

5. Do one of the following:

- If you don't want the scenario to run automatically, click **No**. Skip to step 7 to remove the card and insert it in the projector.
- If you want it to run automatically, click **Yes**. Continue with the following instructions.

You see the Edit Autorun window:

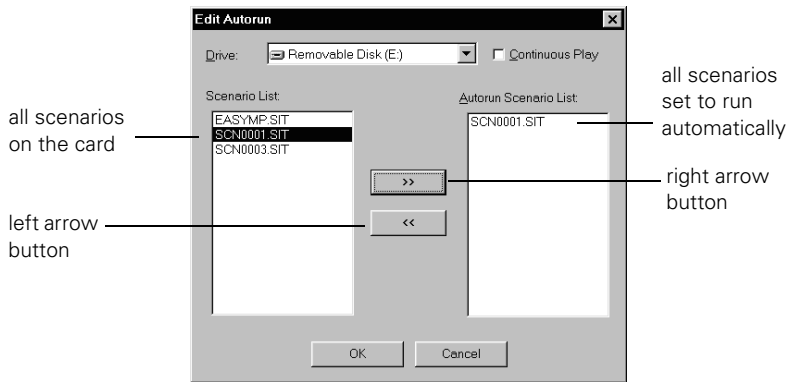

note

If you want to change the autorun setting for the built-in demo (or any other scenario), you can open the Scenario Option menu and select Edit Autorun.

All the scenarios on the card appear on the left. Any scenario that is set to run automatically also appears on the right. You can select scenarios and use the arrow buttons in the center of the screen to move them from one side to the other.

- If you want your new scenario to run automatically, click it in the Scenario List, then click the right arrow button to move it to the Autorun Scenario List.
- To stop the built-in demo (EASYMP.SIT) from running automatically, click it in the Autorun Scenario List, then click the left arrow button to move it off the list.
- Click the **Continuous Play** box if you want your scenario to repeat continuously. Clear the checkbox if you want it to play only once.

6. Do one of the following:

- If the memory card is inserted in the projector, you can begin your presentation as described in Chapter 5.
- If the card is in your computer, remove it and insert it in the projector to run your presentation.

See your computer's documentation if you need instructions on removing the card. If you're using Windows 2000 or Me, you first need to click an icon to stop or disconnect the card.

Make sure the button below the memory card slot is pressed in. Then insert the memory card (and adapter) in the projector as shown. Make sure the card faces the back of the projector.

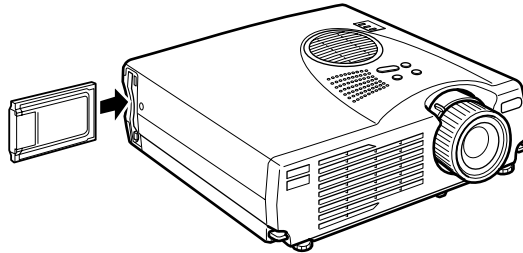

Once your scenario is saved on the card in the projector, follow the instructions in Chapter 5 to present it.

5 *Presenting Without a Computer*

You can run your presentation from the projector without a computer. You need to start by converting a PowerPoint file into a format called a *scenario* and downloading the scenario to the projector's memory card. See Chapter 4 for instructions.

Once the scenario is saved on the memory card in the projector, you can run it automatically or with the remote control. You can also rearrange your slides and show images captured from videos or other sources.

This chapter covers the following:

- Presenting your scenario
- Editing your scenario
- Capturing and playing back images

Presenting Your Scenario

If your scenario is set to autorun, it will start when the projector's lamp comes on after you press the **Power** button. If you didn't change the default settings, each slide will display for 30 seconds. However, you can also display each slide manually, as described on page 57.

To change the autorun setting or add transitions, you need to edit your scenario in EMP SlideMaker on your computer. However, you can change the order or hide slides using EasyMP on the projector, as described on page 58.

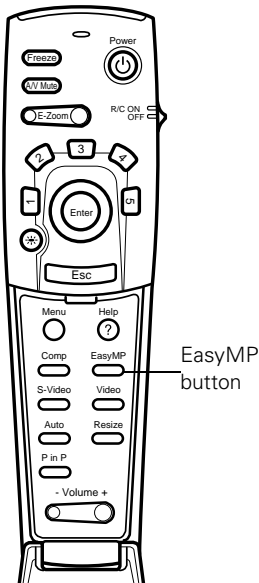

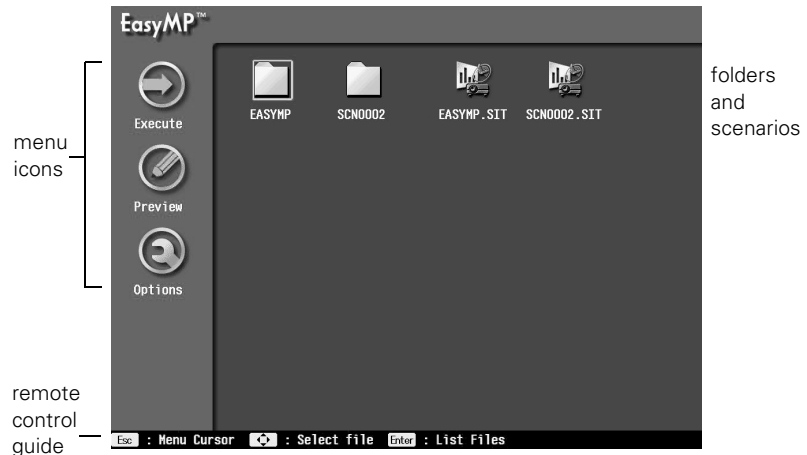

Follow these steps to present your scenario:

1. Turn on the projector. See Chapter 2 if you need instructions.
 - If your scenario is set to autorun, it will start as soon as the projector warms up. You can press **Enter** to display the next slide immediately, or press **Esc** to display the previous slide.
 - If your scenario is not set to autorun, you need to start it manually. Continue with the following steps.
2. Press the **EasyMP** button on the remote control. You see the EasyMP main screen:



Two types of icons appear on the screen:



-  EasyMP creates a folder for each scenario on the card.
 -  Scenarios always have the .SIT file name extension.
3. Use the **Enter** button on the remote control to highlight your  scenario file (SCN002.SIT, for example).
 4. Press **Enter**. In a moment, your scenario begins. Each slide will display for 30 seconds (unless you have set slides to advance on mouse click).

You can press **Enter** to display the next slide immediately, or press **Esc** to display the previous slide.

5. To exit the scenario at any point, press the **EasyMP** button on the remote control. You see a confirmation message.
6. Press **Enter** to exit. In a moment, you return to the EasyMP main screen.

Displaying Each Slide Manually

Even if your scenario is set to change slides automatically, you can still change slides manually.

1. Press the **EasyMP** button on the remote control to display the EasyMP main screen.
2. Use the **Enter** button on the remote control to highlight the  folder icon for your scenario.
3. Press the **Esc** button on the remote control to highlight the  **Execute** icon.
4. Press **Enter** to display the first slide in your scenario.
5. Continue pressing **Enter** to display each slide in sequence.

Press **Esc** to display the previous slide.

6. To exit the scenario at any point, press the **EasyMP** button on the remote control. You see a confirmation message.
7. Press **Enter** to exit. In a moment, you return to the EasyMP main screen.

note

You can modify your scenario using EMP SlideMaker on your computer. However, you can also make certain types of changes using EasyMP without a computer.

Editing Your Scenario

You can modify your scenario using EasyMP on the projector. Some of the things you can do include:

- Rearranging slides
- Hiding individual slides
- Changing the continuous play setting
- Previewing individual slides
- Changing the timing between slides

Rearranging and Hiding Slides

You use the Edit Scenario function to rearrange your presentation or hide individual slides.

1. Press the **EasyMP** button on the remote control to display the EasyMP main screen.
2. Use the **Enter** button on the remote control to highlight your  scenario file. You see a screen like the following:

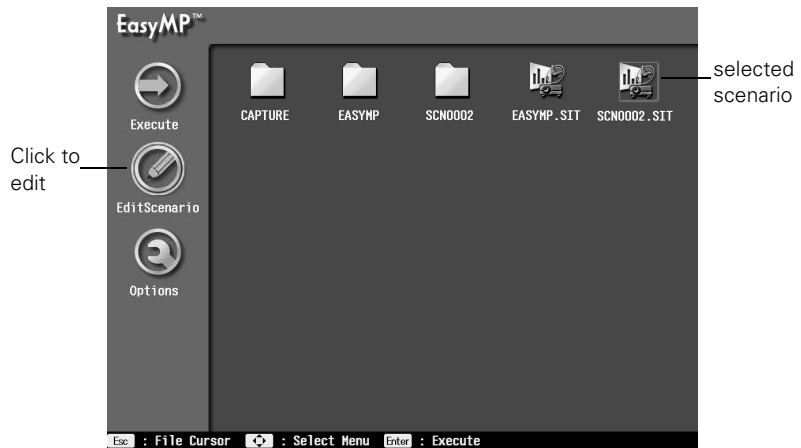

3. Press the **Esc** button on the remote control to access the menu icons on the left side of the screen.

- Use the **Enter** button to highlight  **Edit Scenario**, then press **Enter** to select it.

You see thumbnail images of the slides in your scenario:

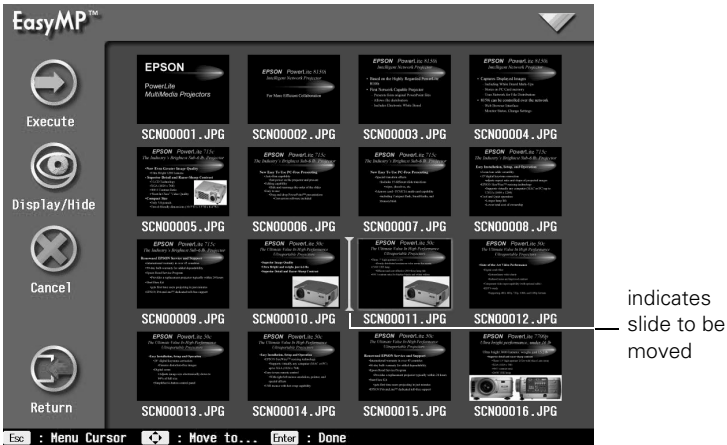

- To move a slide:

Use the **Enter** button to highlight the slide you want to move. Then press **Enter**. A white line (or “I-beam”) appears to the left of the slide.

Use the **Enter** button to move the highlight where you want the slide to appear. Then press **Enter**. The slide moves to the new position.

- To hide a slide:

Use the **Enter** button to highlight the slide you want to hide. Then press **Esc** to access the icons on the left side of the screen.

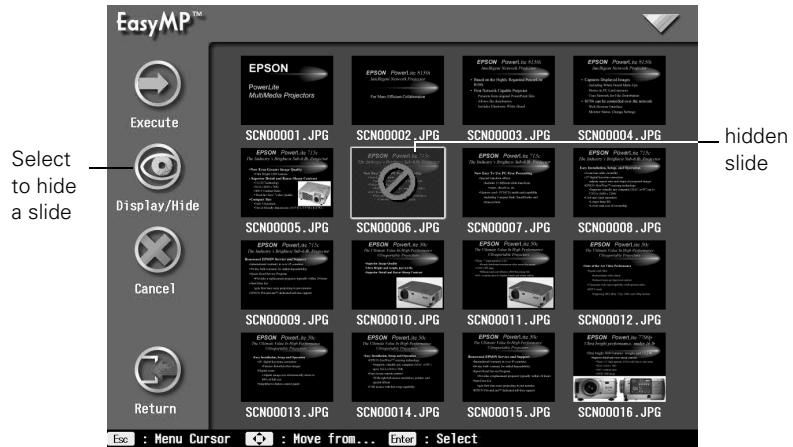

Use the **Enter** button to highlight the  **Display/Hide** icon. Then press **Enter** to select it.

The red non-display icon appears on your slide:



If you change your mind and want to display the slide, repeat the process to remove the non-display icon.

5. Do one of the following:



- To save your changes, press **Esc**, then use the **Enter** button to highlight the  **Return** icon. Then press **Enter**. You return to the EasyMP main screen.
- If you don't want to save your changes, press **Esc**, then use the **Enter** button to highlight the  **Cancel** icon. Then press **Enter**. You return to the EasyMP main screen without saving your changes.
- To save your changes and play the edited scenario, press **Esc**, then use the **Enter** button to highlight the  **Execute** icon. Then press **Enter**. Your changes are saved and the edited scenario begins.

Changing the Continuous Play Setting

You can set a scenario to repeat continuously or to play through only once.

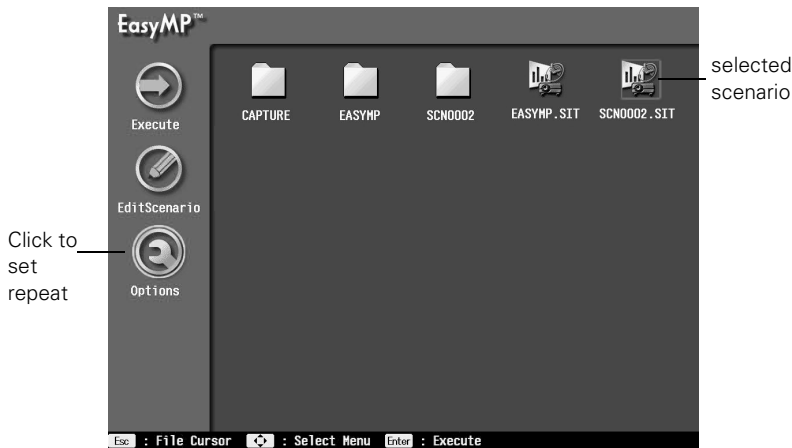
1. Press the **EasyMP** button on the remote control to display the EasyMP main screen.
2. Use the **Enter** button on the remote control to highlight your  scenario file. You see a screen like the following:





3. Press the **Esc** button on the remote control to access the menu icons on the left side of the screen.
4. Use the **Enter** button to highlight the  **Options** icon, then press **Enter** to select it. You see the **Continuous Play** setting.
5. Use the **Enter** button to move the selector to **Yes** (to repeat your scenario) or **No** (to play it only once). Then press **Enter** to select it.
6. Press the **Esc** button on the remote control to access the menu icons on the left side of the screen.
7. Do one of the following:
 - To play your scenario with the new settings, use the **Enter** button to highlight  **Execute**, then press **Enter**.
 - To return to the EasyMP main screen, use the **Enter** button to highlight  **Return**, then press **Enter**.

Previewing Slides

For each folder on the memory card, you can display thumbnails and preview the slides in the folder.

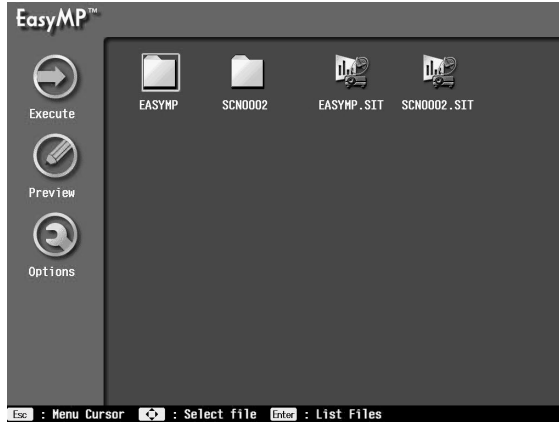
1. Press the **EasyMP** button on the remote control to display the EasyMP main screen.



2. Use the **Enter** button on the remote control to highlight the  folder for your scenario.
3. Press **Esc** to access the menu icons on the left side of the screen.
4. To preview all the files, use the **Enter** button to highlight  **Preview**, then press **Enter** to select it. You see thumbnail images of the slides or other files in the folder:

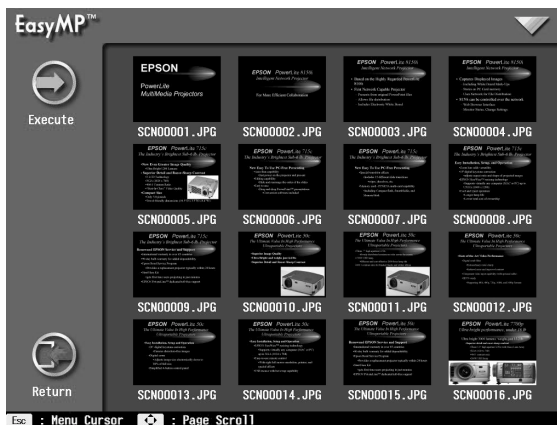

5. Press **Esc** to access the menu icons.
6. Use the **Enter** button to highlight  **Execute**. Press **Enter** to display the first slide in the folder.
7. Press **Enter** to change to the next slide. Continue pressing **Enter** to display each slide in sequence.
Press **Esc** if you want to display the previous slide.
8. Press the **EasyMP** button to end the display. You see a confirmation message.
9. Press **Enter** to exit. In a moment, you return to the EasyMP main screen.

Changing Display Timing and Other Settings

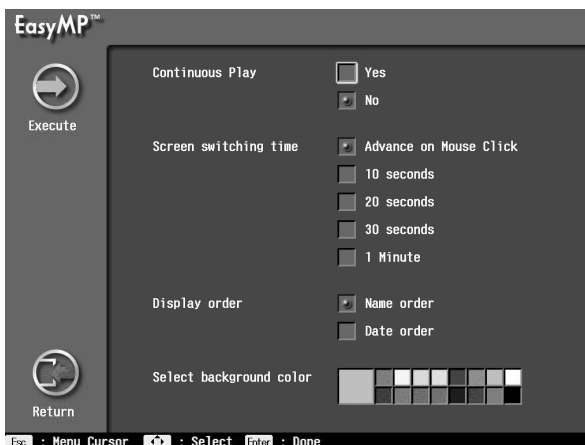

For each folder on the memory card, you can set the display timing for your slides and change several other display features. In effect, you can create a new scenario from your slides or other images.

1. Press the **EasyMP** button on the remote control to display the EasyMP main screen.
2. Use the **Enter** button to highlight the folder you want.
3. Press **Esc** to access the menu icons on the left side of the screen.
4. Use the **Enter** button to highlight  **Options**, then press **Enter**. You see a display options screen like the following:



note

You can also change all of these settings using EMP SlideMaker on your computer.

5. Use the **Enter** button to select the following settings. After you make your choice for each option, press **Enter** to enable the change.
 - **Continuous Play**
Determine whether to repeat the display of slides or images in the folder.
 - **Screen switching time**
Set the display time for each slide or image. Choose **Advance on Mouse Click** if you want to change slides manually.
 - **Display order**
Choose between displaying alphabetically by file name or by image file date.
 - **Select background color**
The color you choose is displayed in the background for images that don't fill the screen area.
6. When you're finished changing settings, press **Esc** to access the menu icons on the left side of the screen. Your changes are saved.
7. Do one of the following:
 - To play your slideshow with the new settings, use the **Enter** button to highlight  **Execute**. Press **Enter** to start displaying the slides or images.
 - To return to the folder display, use the **Enter** button to highlight  **Return**. Press **Enter** to return to the EasyMP main screen.

Capturing Images

EasyMP lets you capture any image displayed on the projector and save it on the memory card. You can capture images from video or computer sources. Once you have captured an image or a series of images, you can play them back through EasyMP.

Saving Images on the Memory Card

You use the projector's built-in Capture menu to capture and save images on the memory card. Start by displaying the image you want—either from a computer source or a video source such as a VCR or digital camera.

1. Press the **Menu** button on the remote control. You see the main menu.
2. Press down on the **Enter** button to highlight the **Capture** menu.

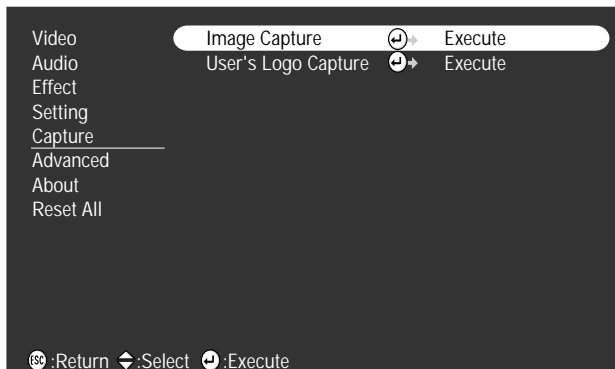

3. Press **Enter** to highlight **Image Capture** and press **Enter** again to select it. You see the message shown at the right.
4. Select **Yes** and press **Enter**.
5. When you see the message “Do you use this image?” select **Yes** and press **Enter**.



Saving the image may take a few moments. Do not use the projector or other sources (computer, video, speaker, etc.) while the image is being saved.

- When you see the message “This image was saved as CAP_001.JPG in the Memory Card,” press the **Menu** button to exit the projector menus.

Previewing Captured Images

Captured images are saved in the **CAPTURE** folder on the memory card. You can view them and play them back through EasyMP the same as other images on the card.

- Press the **EasyMP** button on the remote control to display the EasyMP main screen.



- Use the **Enter** button on the remote control to highlight the **CAPTURE** folder.
- Press **Enter** to open the folder.

You see icons for the images in the folder:

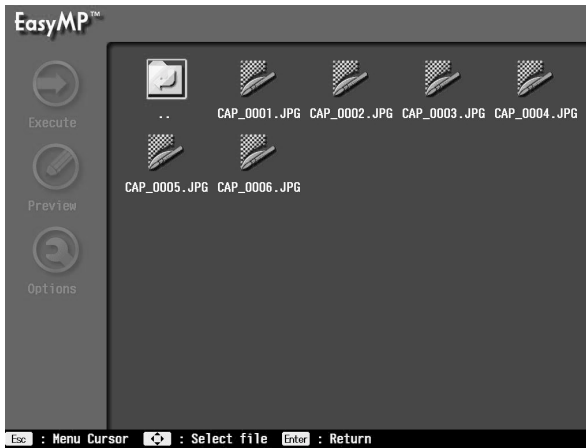

4. To preview an image, use the **Enter** button to highlight it, then press **Enter** to display it. To return to the folder display, press **Esc**.
5. To return to the EasyMP main screen, use the **Enter** button to highlight the  folder icon. Then press **Enter**.

You can also play back your captured images as a slide show and set the playback timing and other options. See pages 62 to 64 for instructions.

6 *Fine-tuning the Projector*

You can use the projector's on-screen menus to adjust the image, sound, and other features. You can also create your own startup screen, customize the highlighting tools, and find out how long your lamp has been in use. This chapter covers the following information:

- Using the menu system
- Adjusting the image
- Adjusting the sound
- Customizing the highlighting controls
- Creating your own startup screen
- Customizing projector features
- Viewing lamp usage and other information
- Restoring the default settings

Using the Projector's Menu System

The eight projector menus let you adjust and customize the projector features from the remote control:

- The Video menu controls the look and quality of the projected image. It lets you adjust the image position and fine-tune settings such as Brightness, Sharpness, and Contrast.
- The Audio menu controls the volume level, treble, and bass settings.
- The Effect menu lets you change the cursor speed and modify the highlighting tools available on the remote control.
- The Setting menu allows you to set or adjust features such as the Picture in Picture (P in P) video source, blank screen color, A/V Mute display option, and sleep mode.
- The Capture menu lets you capture and store a custom image or logo which you can then use as a startup screen or with the A/V Mute option. You can also capture and store images on the memory card, as described on page 65.
- The Advanced menu lets you specify additional projector settings, including menu language, startup screen, color setting, and rear or ceiling projection.
- The About menu provides information about lamp status and computer or video settings.
- The Reset All menu lets you restore the factory defaults for all the projector settings.

Changing Menu Settings

You can use the buttons on the remote control to access the menus and change settings. Follow these steps:

1. To display the menu screen, press the **Menu** button on the remote control. You see the menu screen:

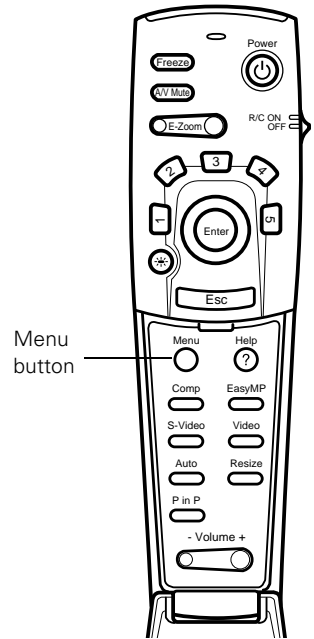
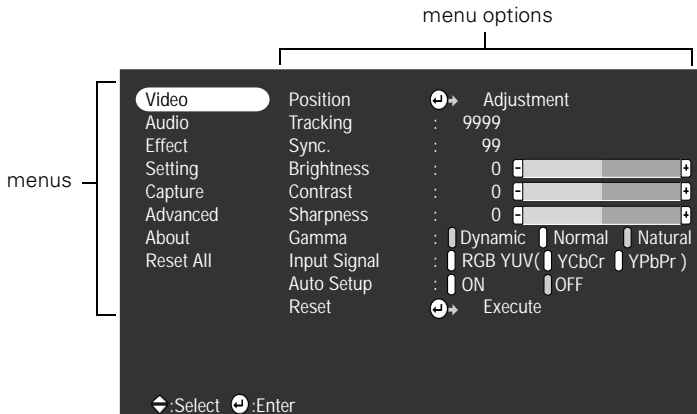

The eight menus are listed on the left, and the options available for the highlighted menu are shown on the right.

2. Press up or down on the **Enter** button to scroll through the menu list.
3. When the menu you want is highlighted, press the **Enter** button to select it. The highlight moves to the first option for that menu.
4. Use the **Enter** button to scroll through the list of options. (If a computer or video source isn't connected, certain options may be unavailable.)
5. Use the **Enter** button to change the setting for the selected option. Enabled settings have a green highlight.
6. Press the **Esc** button to return to the main menu. Your changes are saved automatically.
7. Press **Esc** again (or the **Menu** button) to exit the menu system.

note

*If you want to go back to the default settings on any menu, select **Reset**, press **Enter**, select **Yes**, and then press **Enter**.*

Adjusting the Image

The Video menu lets you make adjustments to the projected image. The options available in the menu depend on which source is selected: standard computer video, EasyMP, composite or S-Video, or component video.

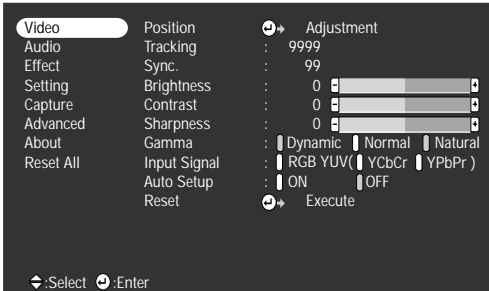

Video menu for standard computer display



Video menu for EasyMP

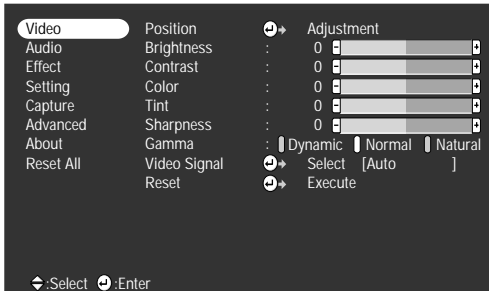

Video menu for composite video or S-Video

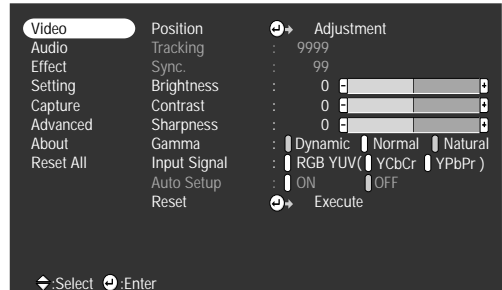

Video menu for component video

Repositioning the Image

Follow these steps to fine-tune the image position:

1. Press the **Menu** button. You see the main menu.
2. Press **Enter** to select the Video menu.
3. Press **Enter** to select the **Position** option. You see the following on the right side of the screen:

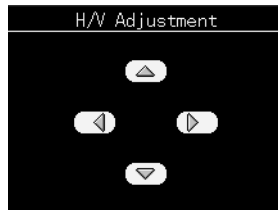

4. Use the **Enter** button to move the image left, right, up, or down.
5. When the image is positioned the way you want, press **Esc**.

Adjusting Image Appearance

Follow these steps to adjust the appearance of your image:

1. Press the **Menu** button. You see the main menu.
2. Press **Enter** to select the Video menu.
3. Use the **Enter** button to set one of the following options:
 - **Tracking (computer images only)**
Removes unwanted vertical lines from a computer image by matching the projector's internal clock to various computer signals.
 - **Sync (computer images only)**
Corrects fuzziness or screen flicker by synchronizing the projector with the tracking signal sent from the computer.
 - **Brightness**
Lightens or darkens the overall image.
 - **Contrast**
Adjusts the difference between light and dark areas.

note

*If you have repositioned the image, you can use the **Auto** button on the remote control to restore the default settings.*

- **Color (composite video or S-Video only)**
Adjusts the depth or intensity of the image.
 - **Tint (video only)**
Adjusts the balance of green to magenta in the image.
 - **Sharpness**
Sharpens or softens the image.
 - **Gamma**
Choose **Dynamic** for computer images with bright colors (such as charts or graphs), **Normal** for the default, or **Natural** to enhance video images.
 - **Input Signal**
Leave this setting on **RGB** when a computer is connected to the **Computer/Component Video** port. When a component video source is connected, choose **YCbCr** or **YPbPr**, depending on the type of signals produced by your source. (You can tell which setting is correct by the quality of the projected image.)
 - **Auto Setup**
Leave this setting **ON** to automatically optimize the computer image. Turn it off if you want to save adjustments you have made to the video settings.
4. When the image is set correctly, press **Esc** or **Menu**. Your settings are automatically saved.

Adjusting the Sound

You can use the Audio menu to adjust the sound volume or treble/bass balance.

1. Press the **Menu** button. You see the main menu.
2. Use the **Enter** button to highlight **Audio**.

You see the following:

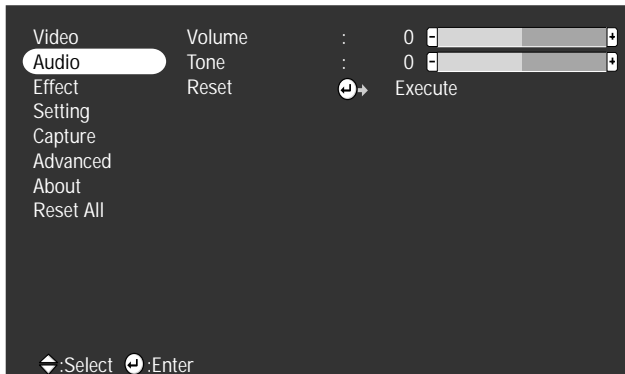

3. Press **Enter** to select the Audio menu.
4. Use the **Enter** button to set the following options:
 - **Volume**
 - **Tone** (treble/bass balance)
5. When you're finished adjusting the sound, press **Esc** or **Menu**.

Customizing the Highlighting Tools

The highlighting tools let you add pointers and other types of annotations to your image, as described on pages 35 to 37. You can use the Effect menu to customize these tools and set the cursor speed for highlighting. The **Reset** option lets you return all the highlighting tools to their default settings.

1. Press the **Menu** button. You see the main menu.
2. Use the **Enter** button to highlight **Effect**.

You see the Effect menu:

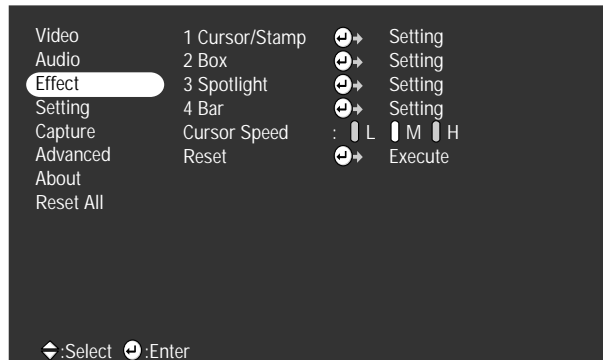

3. Press **Enter** to select the Effect menu.
4. Use the **Enter** button to customize:
 - **Cursor/Stamp**
Lets you define the shape and size for the pointer. For some pointers, you can also define the color and length.
 - **Box**
Lets you define the box color and choose from a solid or outline box, with rounded or square corners.
 - **Spotlight**
Lets you choose a large, medium, or small spotlight.
 - **Bar**
Lets you set the bar color and width, and choose between vertical and horizontal bars.
 - **Cursor Speed**
Lets you choose low, medium, or high speed for highlighting.
5. Use the **Enter** button to make your selections.
6. When you're finished customizing the highlighting tools, press **Esc** or **Menu**. Your selection(s) are saved.

Creating Your Own Startup Screen

You can transfer any image on your computer to the projector, and then use it as the screen displayed when the projector is not receiving a signal. You can also set it to be displayed when you press the **A/V Mute** button, or as a startup screen. The image can be a company logo, slogan, photograph, or any other image you want to use.

You can also use the Capture menu to capture and save images on the memory card. See page 65 for instructions.

Capturing the Image

Start by displaying the image you want to use on the projector. You can use an image from either a computer or video source such as a VCR or digital camera. Then follow these steps to capture the image and transfer it to the projector:

1. Press the **Menu** button on the remote control. You see the main menu.
2. Use the **Enter** button to highlight the **Capture** menu.

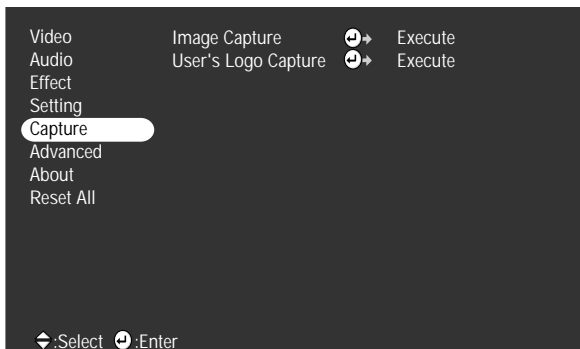

3. Use the **Enter** button to highlight **User's Logo Capture** and press **Enter** again to select it. You see the message shown at the right.
4. Select **Yes** and press **Enter**. A selection box displays over the image.





5. Use the **Enter** button to select the area of the image you want to use. Once you have selected the entire area, press **Enter**.
6. When you see the message “Do you use this image?” select **Yes** and press **Enter**. If you want to change the area selected, select **No**, press **Enter** and repeat steps 4 through 6. You see a message like the one at the left.
7. Use the **Enter** button on the remote control to select a zoom rate (display size), and then press **Enter**.
8. When you see the message “Do you save the user’s logo?,” select **Yes** and press **Enter**.

Saving the logo may take a few moments. Do not use the projector or other sources (computer, video, speaker, etc.) while the logo is being saved.

9. When you see the message “Saving the user’s logo is completed,” press **Esc** or **Menu**.

Setting Up When the Image Displays

After your image is saved, you can set it up as the no-signal message and/or the screen that’s displayed when you press the **A/V Mute** button.

1. Press the **Menu** button to display the main menu (if not already displayed).
2. Use the **Enter** button to highlight **Setting**.
3. Press **Enter** to select the **Setting** menu.
4. Use the **Enter** button to highlight **No-Signal Msg.**
5. Use the **Enter** button to select **Logo**. This sets your image as the screen displayed when the projector is not receiving a signal.
6. If you want to set up your image as the **A/V Mute** display, use the **Enter** button to move down to **A/V Mute**.
7. Use the **Enter** button to select **Logo**. This sets your image as the screen displayed when you press the **A/V Mute** button.
8. When you’re finished, press **Esc** or **Menu**.

note

*You can also set up your image as a startup screen. Use the **Advanced** menu to enable the startup screen; see page 80.*

To test your setting, press the **A/V Mute** button to display your image. Press it again to turn off the image.

Customizing Projector Features

You can use the Setting menu to disable the projector's sleep mode, adjust the image shape, and customize several other features.

1. Press the **Menu** button.
2. Use the **Enter** button to highlight **Setting**. You see the features and their settings on the right side:

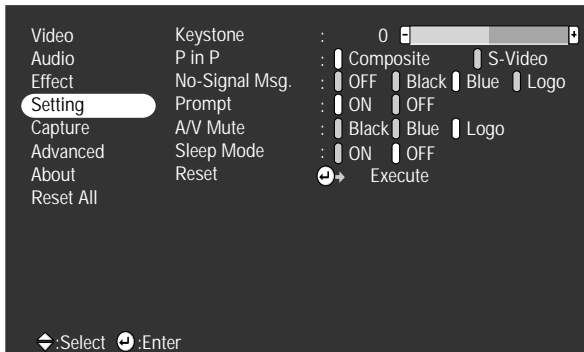

3. Press **Enter** to select the Setting menu.
4. Use the **Enter** button to set the following options:
 - **Keystone**
Adjusts a distorted image from a trapezoid shape to rectangular.
 - **P in P**
Changes from a composite (standard) video source to an S-Video source for the picture-in-picture display.
 - **No-Signal Msg.**
Selects the screen color and message to display when the projector is not receiving a signal. The logo setting displays an image that you have transferred to the projector. See page 77 for instructions on transferring an image to use as the no-signal message.

- **Prompt**
Turns off the identifying text that appears briefly when you switch from computer input to a video source.
- **A/V Mute**
Selects the screen color or image to display when you press the **A/V Mute** button. The logo setting displays an image that you have transferred to the projector. See page 77 for instructions on transferring an image to use for the A/V Mute display.
- **Sleep mode**
Disables the power management system. Normally, the lamp turns off when the projector has not received any input signals for 30 minutes.

5. When you're finished, press **Esc** or **Menu**.

Setting Advanced Features

You can use the Advanced menu to configure the projector for rear projection or ceiling mounting, and adjust several other features.

1. Press the **Menu** button.
2. Use the **Enter** button to highlight **Advanced**. You see the features and their settings on the right side:

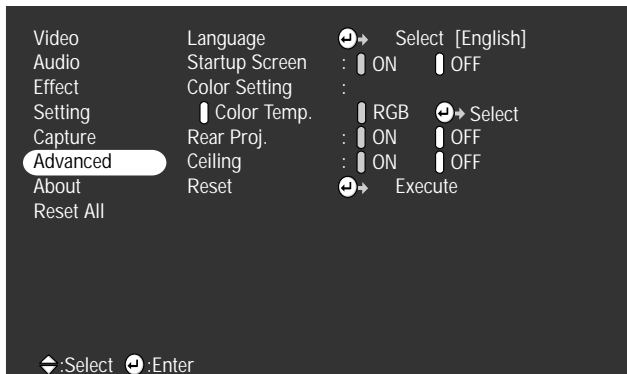

3. Press **Enter** to select the Advanced menu.

4. Use the **Enter** button to set the following options:
 - **Language**
Select from nine languages to be used for the projector menus.
 - **Startup Screen**
Turn on to display the image or logo you have captured whenever the projector starts. See page 77 for more information.
 - **Color Setting**
Adjusts the color temperature of the projected image. Select **Color Temp.** and press **Enter** to set a temperature between 5000 and 10000 K. Select **RGB** and press **Enter** to adjust individual red, green, and blue values, as shown at the right.
 - **Rear Proj.**
Turn on to project from behind onto a transparent screen.
 - **Ceiling**
Turn on when the projector is mounted upside-down from the ceiling.
5. When you're finished, press **Esc** or **Menu**.

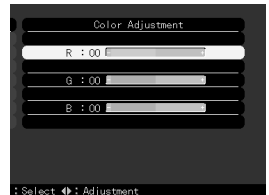

Viewing Lamp Usage and Other Information

Use the About menu to view information about the display settings of your computer and the number of hours the lamp has been used.

1. Press the **Menu** button. You see the main menu.
2. Use the **Enter** button to select **About**.

note

If you access the About menu when the projector display is set to video, you only see the lamp life and the video signal setting.

You see the lamp usage hours and computer display settings on the right:

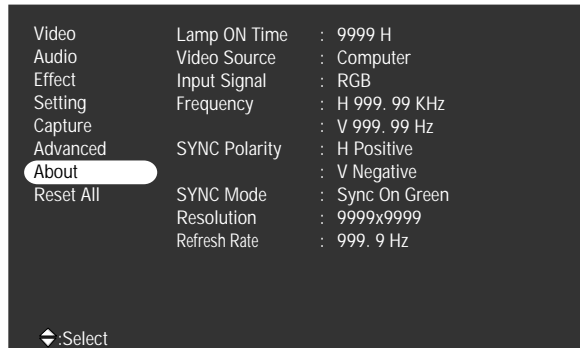

The life span of the lamp is about 1000 hours. If the number shown is close to 1000, make sure you have a spare lamp handy.

3. When you're finished, press **Esc** or **Menu**.

Restoring the Default Settings

The Reset All option lets you return all the projector settings to their default values.

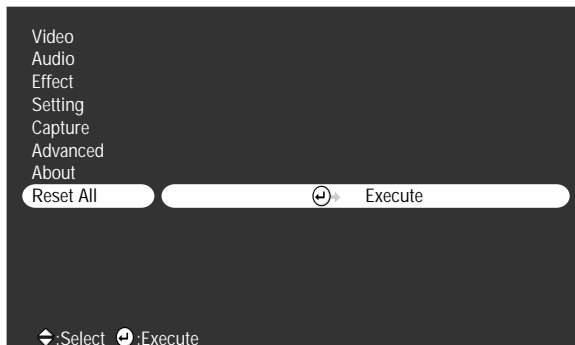

Select **Reset All** and press the **Enter** button on the remote control to display the confirmation screen. Select **Yes** to reset all the default settings or **No** to cancel.

7 *Maintaining and Transporting the Projector*

warning

Before you clean any part of the projector, turn it off and unplug the power cord. Never open any cover on the projector, except the lamp and filter covers. Dangerous electrical voltages in the projector can injure you severely. Do not try to service this product yourself, except as specifically explained in this User's Guide. Refer all other servicing to qualified service personnel.

Your projector needs little maintenance. All you need to do on a regular basis is keep the lens clean. Any dirt or smears on the lens may show up on your projected image.

You also need to periodically clean the air filter on top of the projector. A clogged air filter can block ventilation needed to cool the projector and keep it from overheating.

The only parts you should replace are the lamp and air filter. If any other part needs replacing, contact your dealer or a qualified servicer.

This chapter covers the following:

- Cleaning the lens
- Cleaning the projector case
- Cleaning and replacing the air filter
- Replacing the lamp
- Transporting the projector

Cleaning the Lens

Clean the lens whenever you notice dirt or dust on the surface.

- Use a canister of compressed air to remove dust.
- To remove dirt or smears on the lens, use lens-cleaning paper. If necessary, moisten a soft cloth with lens cleaner and gently wipe the lens surface.

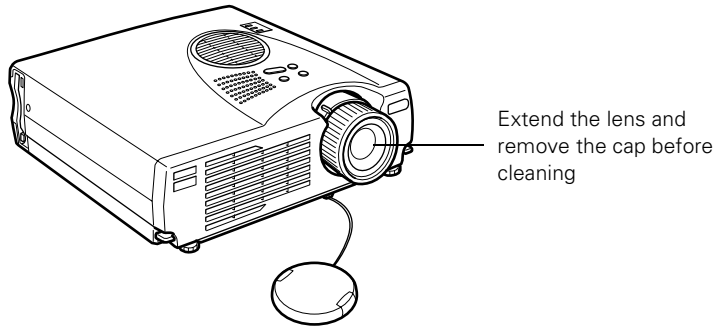

Cleaning the Projector Case

Before you clean the case, first turn off the projector and unplug the power cord.

- To remove dirt or dust, wipe the case with a soft, dry, lint-free cloth.
- To remove stubborn dirt or stains, moisten a soft cloth with water and a neutral detergent. Then wipe the case.
- Do not use wax, alcohol, benzene, thinner, or other chemical detergents. These can damage the case.

Cleaning and Replacing the Air Filter

Clean the air filter on top of the projector after every 100 hours of use. If it is not cleaned periodically, it can become clogged with dust, preventing proper ventilation. This can cause overheating and damage the projector. To clean the air filter, follow these steps:

1. Turn off the projector, allow it to cool down, and unplug the power cord.
2. Stand the projector on end to keep dust and dirt from falling inside.
3. To clean the filter, EPSON recommends using a small vacuum cleaner designed for computers and other office equipment. If you don't have one, gently clean the filter using a very soft brush (such as an artist's camel-hair brush).

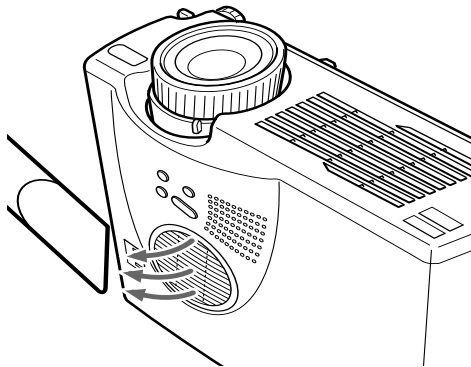

If the dirt is difficult to remove or if the filter is torn, replace it. Contact your dealer or call EPSON at (800) 873-7766 in the United States and Canada to obtain a new one.

note

When you get a replacement lamp for your projector, a new air filter is included. You should replace the filter when you replace the lamp.

4. If you need to replace the filter, use a small screwdriver to pry it off.

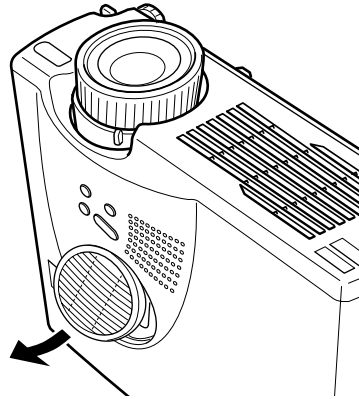

5. To install the new filter, first insert the tab, then press down until it clicks in place.

Replacing the Lamp

note

You can check to see how many hours the lamp has been used. See page 81.

The projection lamp typically lasts for about 1000 hours of use. It is time to replace the lamp when:

- The projection image gets darker or starts to deteriorate.
- The lamp warning light  is flashing red or orange.
- The message **LAMP REPLACE** appears on the screen when the lamp comes on (after about 900 hours of use). To maintain projector brightness and image quality, replace the lamp as soon as possible.

Contact your dealer or call EPSON at (800) 873-7766 in the United States and Canada for a replacement lamp. Request part number ELPLP14.

Follow these steps to replace the lamp:

1. Turn off the projector, then unplug the power cord.
2. Allow the projector to cool down for at least an hour (if it has been on).
3. Turn the projector upside-down to access the lamp compartment.
4. Use a screwdriver to loosen the retaining screw on the lamp cover. (You can't remove the screw from the cover.)

When the screw is loose, lift off the lamp cover.

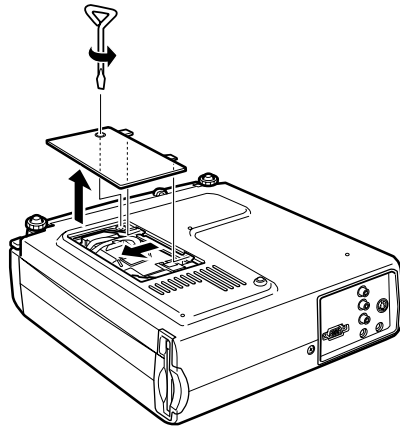

5. Use a screwdriver to loosen the two screws holding the lamp in place. (You can't remove these screws.)
6. Lift up the wire handle, as shown, and pull the lamp straight out.

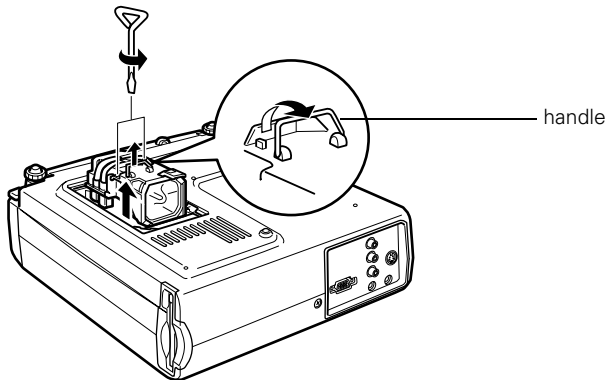

warning

Let the lamp cool before replacing it. If the lamp breaks, handle the shards carefully to avoid injury.

caution

Do not touch the glass portion of the lamp assembly. Touching the glass could result in premature lamp failure.

7. Gently insert the new lamp.
8. Once the lamp is fully inserted, tighten its screws.

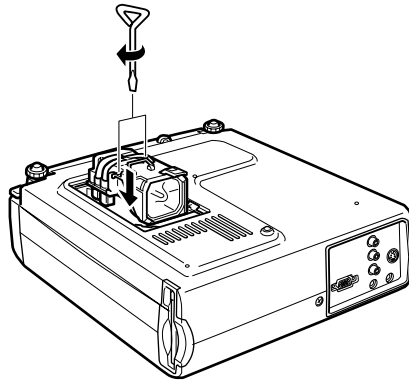

9. Replace the lamp cover and tighten its screw securely. (The projector won't come on if the lamp cover is loose.)

Transporting the Projector

note

EPSON shall not be liable for any damages incurred during transportation.

The projector contains many glass and precision parts. If you need to transport it, please follow these packing guidelines to prevent damage to the projector:

- When shipping the projector for repairs, use the original packaging material if possible. If you do not have the original packaging, use equivalent materials, placing plenty of cushioning around the projector.
- When transporting the projector for business use, first put it in a carrying case (such as an optional EPSON case), then pack it in a firm box, using cushioning around the case.
- When you are hand-carrying the projector, be sure to store it in a carrying case (such as an optional EPSON case).
- If you want to store the remote control inside the projector's carrying case, be sure to turn it off using the switch on its side. This prevents the batteries from discharging if something presses against one of the buttons.

8

Solving Problems

This chapter helps you solve problems with your projector, and tells you how to contact technical support for problems you can't solve yourself. This chapter explains the following:

- Using the projector's on-screen help system
- What to do when the projector's status lights flash
- Solving problems with the image or sound
- Solving problems with the remote control
- Solving EasyMP problems
- EasyMP error messages
- Contacting technical support

Using On-Screen Help

If the image doesn't look right or your audio isn't working, you can get help by pressing the blue ? **Help** button on top of the projector or under the cover on the remote control. The following choices are available:

- Help for the image
- Help for the sound
- Language selection

Follow these steps to get help:

1. Press the blue ? **Help** button on the projector or the remote control. You see the help menu.
2. Press the side of the **Select (Keystone)** button on the projector (or use the **Enter** button on the remote control) to highlight one of the options. Then press the **Enter (Source)** button to select it.
3. Press the side of the **Select (Keystone)** button on the projector (or use the **Enter** button on the remote control) to highlight the problem you want to solve. Then press the **Enter (Source)** button to view the solution(s).
4. Highlight a solution (if this choice is available). Then press the **Enter (Source)** button to select the solution.

Highlight **Return** and press the **Enter (Source)** button if you need to back up.

If the solution is to adjust one of the settings, press the side of the **Select (Keystone)** button on the projector (or use the **Enter** button on the remote control) to adjust it.

5. To exit the Help system, press the blue ? **Help** button.

If none of the suggestions solves your problem, see additional solutions to problems in the following sections.

What To Do When the Lights Flash

The lights on top of the projector indicate the projector's status and let you know when a problem occurs.

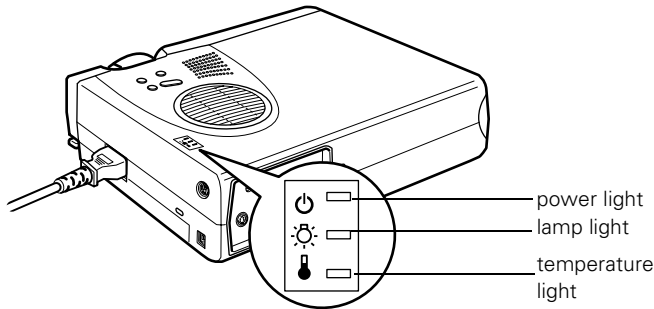

If the projector is not working correctly, first turn it off and unplug it. Then plug the power cord back in and turn on the projector. If this does not solve the problem, check the status lights on top of the projector and try the solutions recommended below.

The power light is flashing orange and you cannot turn on the projector.

The lamp is cooling down. Wait until the light turns off and then press the **Power** button to turn on the projector.

The power light does not come on.

Make sure the power cord is connected securely both at the power outlet and the projector. If you have just replaced the lamp, make sure the cover is securely fastened.

The lamp warning light is red or flashing red.

Replace the lamp as described on page 86.

warning

Except as specifically explained in this User's Guide, do not attempt to service this product yourself.

The  temperature light is flashing orange.











- The projector is in a high-temperature cooling cycle. Make sure the room temperature does not exceed 104 °F and there is plenty of space around and under the projector for ventilation.
- The air filter may be clogged. Clean or replace it as described on page 85.

The  temperature light is red.

- The projector has overheated and turned off. Let the projector cool for a few minutes, then turn it back on. Make sure the room temperature is not above 104 °F and there is plenty of space around and under the projector for ventilation.
- The air filter may be clogged. Clean or replace it as described on page 85.
- If the projector continues to overheat after you clean the air filter, the problem may be caused by damage to the cooling fan or internal circuits. Contact EPSON for help.

Refer to the following table for a complete description of the projector's status lights and their meaning:

Status lights

Light	Status	Description
	orange	The projector is in sleep mode. You can unplug it or press the Power button to turn it on.
	flashing green	The projector is warming up. Wait for the image to appear.
	green	The projector is operating normally.
	flashing orange	The projector is cooling down. You can't turn it back on (and you should not unplug it) until the light stops flashing and remains orange.
	flashing red	Power is cut off because of an internal problem. Remove the power cord and contact EPSON for help.
	red	The lamp is burned out. Replace it as described on page 86.
	flashing orange	The lamp is almost burned out. This is a good time to replace it. See page 86 for instructions.
	flashing red	There is a problem with the lamp. If necessary, replace the lamp as described on page 86.
	flashing orange	The projector is in a high-temperature cooling cycle. Make sure the temperature surrounding the projector does not exceed 104 °F and there is plenty of space around and under the projector for ventilation. Clean the air filter if necessary. See page 85 for instructions.
	red	The projector has overheated and turned itself off. Let it cool for a few minutes, then turn it back on. Make sure there is plenty of space around and under the projector for ventilation. If it continues to overheat, you may need to change the air filter. See page 85 for instructions.
	flashing red	There is a problem with the cooling fan or temperature sensor. Turn off the projector and unplug it. Contact EPSON for help.

Solving Problems with the Image or Sound

No image appears on the screen.

- Check that the power light is green, not flashing, and the lens cap is off.
- The projector may be in sleep mode. If the power light is orange, press the **Power** button to turn the projector on.
- If the power was switched off and then on again, the projector may still be cooling down. Wait until the power light stops flashing and remains orange; then press the **Power** button again.
- Make sure the **Brightness** setting on the Video menu is correct. See page 73 for more information. Try selecting the **Reset All** setting to return all setup menus to their default values.
- Press the **A/V Mute** button to make sure the picture has not been turned off temporarily.
- The attached computer may be in sleep mode or displaying a black screen saver. Try pressing a key on the computer.

You see a blue screen with the message No Signal displayed.

- Make sure the cables are connected correctly, as described in Chapter 1 or Appendix A.
- Try restarting your computer.
- If you've connected a computer and one or more video sources, you may need to press the **Source** button (on the projector) or the **Comp**, **Video**, or **S-Video** button (on the remote control) to select the correct source. Allow a few seconds for the projector to sync up after pressing the button.

If you're using a PC laptop:

- Hold down the Fn key and press the function key that lets you display on an external monitor. It may have an icon such as , or it may be labelled CRT/LCD. Allow a few seconds for the projector to sync up after pressing it. Check your laptop's manual or online help for details.

On most systems, the  key lets you toggle between the LCD screen and the projector, or display on both at the same time.

- Depending on your computer's video card, you might need to use the Display utility in the Control Panel to make sure that both the LCD screen and external monitor port are enabled. See your computer's documentation or online help for details.

If you're using a PowerBook:

1. From the Apple menu, select **Control Panels**, then click **Monitors and Sound**.
2. Click the **Arrange** icon.
3. Drag one monitor icon on top of the other. This lets you display on the projector screen as well as the LCD screen.
4. If this option isn't available, click the **Monitor** icon.
5. Select one of the listed **Simulscan** resolutions. (Allow a few seconds for the projector to sync up after making the selection.)

The message **Not Supported is displayed**.

Make sure your computer's resolution doesn't exceed UXGA (1600 × 1200, for the PowerLite 715c) or SXGA (1280 × 1024, for the PowerLite 505c), and the frequency is supported by the projector (see page 124). If necessary, change your computer's resolution setting as described on page 96.

Only part of the computer image is displayed.

- Press the **Resize** button on the remote control.
- Make sure the image **Position** setting is correct on the Video menu. See page 73 for more information.
- Make sure the **Input Signal** setting is correct on the Video menu. See page 74 for more information.
- Make sure your computer's resolution setting is correct. Ideally, it should be 1024×768 to match the projector's native resolution (800×600 on the PowerLite 505c). If this option isn't available, select one of the other compatible video formats listed on page 124.
 - **Windows:**
Right-click the desktop, select **Properties**, click the **Settings** tab, and use the dialog box to select a different resolution.
 - **Macintosh:**
On the Apple menu, choose **Control Panels**, then click **Monitors and Sound**. Select a different resolution.
- You also may need to modify existing presentation files if you created them for a different resolution. See your software documentation for specific information.

The image isn't square, but trapezoid-shaped.

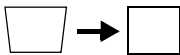
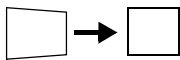

- Make sure the projector isn't placed off to one side of the screen, at an angle, or the image won't be square. Place the projector directly in front of the center of the screen, facing the screen squarely.
- If you've tilted the projector upward by extending the legs, the image will be broader at the top. Hold down the **+** or **-** side of the **Keystone** button on top of the projector until the image is square.

The image contains static or noise.

- If you're using a computer cable longer than 6 feet, or an extension cable, the image quality may be reduced.
- Keep your computer and video cables separated from the power cord as much as possible to prevent interference.
- The video signal may be split between the computer and the projector. If you notice a decline in the projected image quality when the image is displayed simultaneously on your laptop computer and the projector, turn off the laptop's LCD display.

The image is blurry.

- There may be dirt or smears on the lens. Clean the lens as described on page 84.
- Make sure the lens is fully extended.
- Adjust the focus using the focus ring.
- Make sure the lens is not fogged by condensation. You may need to wait before using the projector after moving it from a cold environment.
- Adjust the **Sharpness** setting on the Video menu (see page 73). When you change video settings, you should be able to see the effect on the screen immediately. If you're projecting from a computer, you may also need to adjust the Tracking and Sync as described in the next section. If you don't like the new settings, you can always select **Reset** to return to the factory default settings.

You see vertical stripes or the image still looks blurry after trying the solutions in the previous section.

- If you're projecting from a computer and displaying an image that contains a lot of fine detail, you may notice one or more vertical stripes or bands, or some of the characters may look heavy or blurred. Press the **Auto** button on the remote control. This resets the projector's tracking and sync settings.
- If further adjustment is needed, you can fine-tune the **Tracking** and **Sync** settings manually using the **Video** menu as described on page 73.
 1. Fill the screen with an image containing fine detail when making these adjustments. For example, in Windows you can select a pattern to appear as your desktop background. If this option isn't available, try projecting black text on a white background.
 2. Adjust the **Tracking** to eliminate vertical stripes.
 3. Adjust the **Sync** to increase the sharpness of the image.



The colors of the image are not right.

- If you're displaying a computer image, use the **Gamma** option in the projector's **Video** menu to select **Dynamic** or **Natural** coloring. If you're displaying video, adjust the **Color**, **Tint**, and **Gamma** settings on the **Video** menu.
- Try adjusting the **Color Setting** option on the **Advanced** menu.
- Make sure the **Input Signal** setting is correct on the **Video** menu. See page 74 for more information.
- Check your computer display settings to correct the color balance.

note

Because of the different technologies used, your projected image may not exactly match the colors on your laptop or computer monitor.

There is no sound.

- Try turning up the volume. Press the right side of the **Volume** button on the remote control.
- If you're using a VCR or other video source, make sure the volume is not turned all the way down or muted. Also, make sure the cables are connected correctly, as described in Chapter 1.
- If your presentation includes computer audio, make sure the volume control on your computer is not turned all the way down or muted. Make sure the audio cable is securely connected to both the projector and your computer's  headphone jack or  audio out jack. See page 14 (for laptops) or Appendix A (for other systems).
- Make sure the Windows volume controls on your computer are not turned all the way down or set to Mute. You may be able to check this by right-clicking the sound icon on your Windows desktop.
- Make sure the **A/V Mute** button is not enabled.
- The wrong source may be selected. Press the **Source** button on the projector—or the **Comp**, **Video**, or **S-Video** button on the remote control—to select the correct source.

Solving Problems with the Remote Control

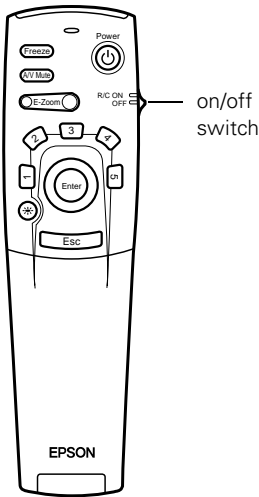

The projector doesn't respond to remote control commands.

- Make sure the remote control is turned on.
- Make sure you are within 30 feet of the projector, and within range of the projector's front or back sensor (approximately 30° to left or right and 15° above or below).
- The remote control batteries may not be installed correctly or may be low on power. To test the batteries, press the ☀ light button. The other buttons on the remote should light up temporarily. If they don't, you need to change the batteries as described on page 30.
- Dim the room lights and turn off any fluorescents. Make sure the projector is not in direct sunlight. Strong lighting, especially fluorescent lights, may affect the projector's infrared receivers.
- Turn off any nearby equipment that emits infrared energy, such as a radiant room heater.

You can't control the mouse pointer with the remote control.

- Make sure the mouse cable is securely connected to both your computer's mouse port or USB port and the projector's mouse port. For details, see page 13 (for laptops) or Appendix A (for other systems).
- To use the USB mouse connection on a PC, your system must have a "clean" installation of Windows 98 (SR2), Windows Me, or Windows 2000. The connection may not work correctly if your system was upgraded from Windows 95.

USB support requires OS9 or higher on a Macintosh.

Solving EasyMP Problems

An image displayed with EasyMP appears distorted.

Because of their resolution, some JPEG images cannot be displayed correctly. Some JPEG files from digital cameras cannot be previewed. Files with a high compression ratio may appear blurry.

In EMP SlideMaker, some PowerPoint files don't appear in the file window.

EMP SlideMaker does not support PowerPoint 95. Files created in this version of PowerPoint must be opened and resaved in PowerPoint 97 or later.

In EMP SlideMaker, your PowerPoint files don't display thumbnails and can't be pasted into scenarios.

If you use PowerPoint 97, make sure the MS Office JPEG converter has been installed. Run the Office 97 installer, display the **Converters and Filters** option, and install the JPEG filter.

You can't edit scenario files in EMP SlideMaker after they have been transferred to the memory card.

When scenario files are transferred, they are converted to the .SIT format. You can only edit scenarios before they are transferred (in the .SIC format).

You can't access the memory card in the projector through the USB cable.

- To use the USB connection, your system must have a "clean" installation of Windows 98 (SR2), Windows Me, or Windows 2000. The connection may not work correctly if your system was upgraded from Windows 95.
- Make sure the projector is not accessing the memory card.

EasyMP Error Messages

Error discovered in the EasyMP system or No memory card

Insert the memory card all the way into the projector's card slot. See page 54 for instructions.

No displayable file

Only the following file types can be displayed from the memory card with EasyMP: Scenario files (.SIT), JPEG files (.JPG), and Bitmap files (.BMP).

No files

Make sure the memory card is inserted in the projector. Press the EasyMP button on the remote control to update the file display.

Display not possible

Grayscale and progressive JPEG files cannot be displayed. Also, some digital camera images and files that have been processed cannot be displayed.

This size cannot be displayed

Files with a resolution greater than 1024×768 cannot be displayed.

Insufficient image file colors

Only 24-bit files can be displayed. Files with a different color depth must be converted before you can display them.

File cannot be saved

The memory card is full. Delete some files and try saving again.

Capture failed

You cannot capture images when the USB cable is connected to the projector. Remove the USB cable and try capturing again.

Where To Get Help

EPSON provides technical assistance through electronic support services and automated telephone services 24 hours a day, as listed in the following table.

Electronic support and automated telephone services

Service	Access
World Wide Web	From the Internet, you can reach EPSON's product support page at http://support.epson.com . After selecting your product, you can access troubleshooting information, download product documentation, and receive technical advice through e-mail.
Automated Telephone Services	A variety of automated help services are available 24 hours a day, seven days a week. To use these services, you must have a touch tone telephone and call (800) 922-8911 .
Presenters Online	Access tips, templates, and training for developing successful presentations at http://www.presentersonline.com

Telephone Support Services

To use the EPSON PrivateLine Support service, call (800) 637-7661 and enter the PIN on the EPSON PrivateLine Support card included in your *Owner's Kit*. This is the fastest way of speaking to a live representative, and it's free. This service is available 6 AM to 6 PM, Pacific Time, Monday through Friday, for the duration of your warranty period.

You may also speak with a projector support specialist by dialing one of these numbers:

- U.S.: (562) 276-4394, 6 AM to 6 PM, Pacific Time, Monday through Friday
- Canada: (905) 709-3839, 6 AM to 6 PM, Pacific Time, Monday through Friday

Toll or long distance charges may apply.

Before you call, please have the following information ready:

- Product name (EPSON PowerLite 505c/715c)
- Product serial number (located on the bottom of the projector)
- Computer configuration
- Description of the problem

You can purchase screens, carrying cases, or other accessories from EPSON at (800) 873-7766 or by visiting www.epson.com (U.S. sales only). In Canada, please call (800) 873-7766 for dealer referral.

A

Appendix A: Connecting to Additional Equipment

This appendix explains how to connect the projector to a desktop computer or Macintosh, or a high-end workstation.

The following information is covered:

- Installing the projector
- Connecting to a PC desktop computer
- Connecting to a desktop Macintosh
- Connecting to a high-end workstation

Installing the Projector

The projector can be installed for three different viewing setups: front projection, ceiling mounting, or rear projection onto a semi-transparent screen.

To project from overhead, you'll need to select **Ceiling** in the projector's Advanced menu. To project from the rear, select **Rear Proj.** See page 80 for more information.

If you're ceiling-mounting the projector and you place it above screen level, you'll have to tilt it down to position the image on-screen. This causes the image to lose its square shape. You can then correct the distortion by using the **Keystone** function in the projector's menu system (see page 79).

If you place the projector's lens so it's level with the top of the screen, the image will be square and you won't have to adjust it. If you place the lens lower than the top of the screen, you'll have to tilt the projector upward if you want to fill the whole screen with the image.

Connecting to an External Audio System

The projector's internal speaker is loud enough for most rooms. However, if your installation requires maximum volume and sound quality, you can connect the projector to external speakers or a public address (PA) system. If you've connected a computer and video source, the projector will automatically switch the audio whenever you switch sources. (See page 32.)

To connect the projector to an external sound system, you will need an RCA-to-3.5 mm stereo audio cable, which may be included with your sound system, or may be purchased from an electronics store.

Before you start, make sure the projector and speakers or PA system are turned off.

1. Connect the cable's 3.5-mm stereo miniplug to the projector's Audio Out jack.

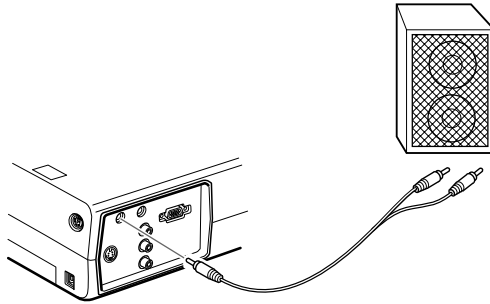

2. Connect the RCA plugs to the speaker or PA system. Insert the cable's red plug into the Audio R jack, and the white plug into the Audio L jack of the external speaker system.

Connecting to a PC Desktop Computer

You can connect the projector to any IBM compatible PC. This section includes instructions for the following:

- Connecting the computer cable
- Connecting the mouse cable (if you want to use the remote control as a mouse)
- Connecting an optional audio cable (if you'll be projecting with audio)

When you connect the projector to a desktop computer, you cannot view your display on the computer monitor.

Follow the steps in each section for the cables you need to connect. Before beginning, turn off the projector and computer if they are on.

Connecting the Computer Cable

1. Disconnect the monitor cable from the video port on the back of the computer.
2. Connect one end of the computer cable to the projector's Computer port.

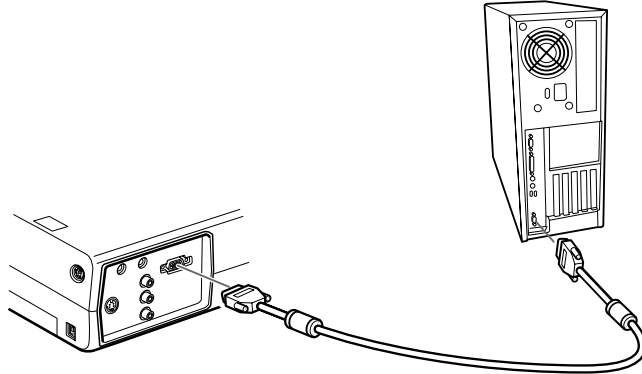

3. Connect the other end of the computer cable to the computer's video port.
4. Tighten the screws on the connectors.

Connecting the Mouse Cable

To use the remote control as a mouse, follow the steps below. You'll use a different mouse cable, depending on whether your computer has a round PS/2 mouse port or a flat USB port.

1. Connect one end of the appropriate mouse cable to the projector's **Mouse/Com** port or the USB port, as shown.

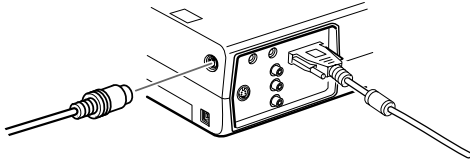

connecting PS/2 mouse cable

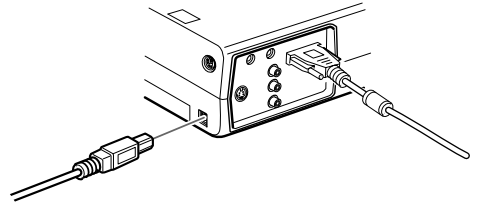

connecting USB mouse cable

2. Disconnect your mouse from the port on the back of your computer and replace it with the other end of the cable. (Your computer's mouse will be disabled while you are using the remote control as a mouse.)

Connecting the Audio Cable

If your presentation includes sound and you want to use the projector's built-in speakers, you can use a computer audio cable. The required cable (3.5-mm stereo miniplug cable) is available from computer or electronics dealers.

1. Connect one end of the audio cable to the **Audio In** jack on the projector.

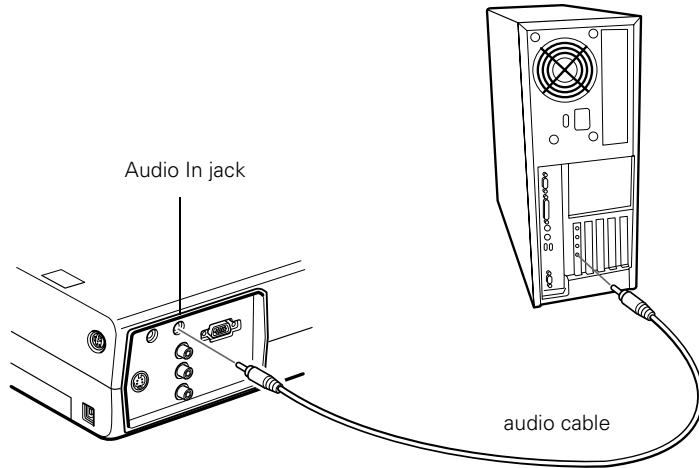

2. Connect the other end of the audio cable to the speaker or audio out port on the computer's sound card.

Connecting to a Desktop Macintosh

You can connect the projector to any desktop Macintosh. This section includes instructions for the following:

- Connecting the computer video cable
- Connecting the mouse cable (if you want to use your remote control as a mouse)
- Connecting an optional audio cable (if you'll be projecting with audio)

When you connect the projector to a desktop Macintosh, you cannot view your display on the Macintosh monitor.

Follow the steps in each section for the cables you need to connect. Before beginning, turn off the projector and computer if they are on.

Connecting the Computer Cable

Follow these steps to connect the computer cable. You may not need to use the adapter as shown.

1. Disconnect the monitor cable from the video port on the back of the Macintosh.
2. Connect one end of the computer cable to the projector's Computer port, as shown.

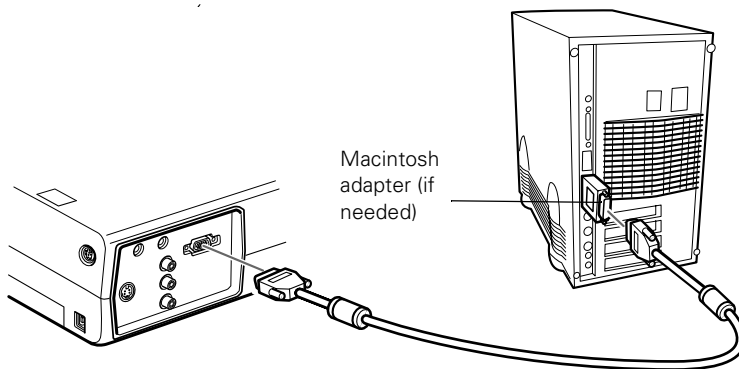

3. Connect the other end of the computer cable to the video port on the Macintosh.

note

Macintosh configurations vary. See your computer manual for the location of the ports needed to connect your projector. Older models may require a Macintosh adapter, which you may purchase from EPSON; see page 8.

If it doesn't fit, you may have to use a Macintosh desktop adapter, which you can buy from EPSON (see page 8).

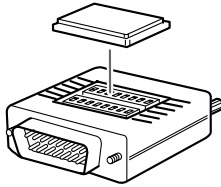

To use the adapter, remove its cover as shown and set its DIP switches according to the resolution you want to use, such as 16-inch mode. See your Macintosh documentation for instructions.

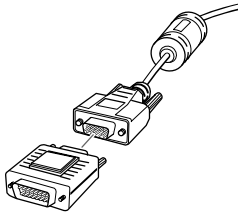

Replace the cover and connect the adapter to the free end of the computer video cable. Then plug the cable (with the adapter) into the video port on your Macintosh.

4. Tighten the screws on the connectors.

Connecting the Mouse Cable

To use the remote control as a mouse, follow the steps below.

If the Macintosh has a USB port, you can use the USB mouse cable that came with the projector. If it has a round mouse port, you'll need a Macintosh ADB mouse cable. See your projector dealer for help in obtaining the correct cable.

1. Connect one end of the mouse cable to the projector's USB port.

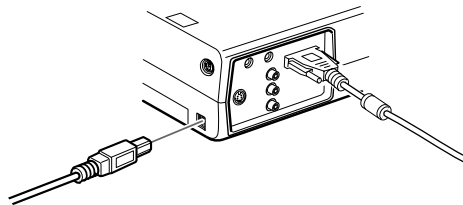

2. Disconnect your Macintosh's mouse cable. Connect the other end of the projector's mouse cable to a USB port on your Macintosh.

Connecting the Audio Cable

If your presentation includes sound and you want to use the projector's built-in speakers, you can use a computer audio cable. The required cable (3.5-mm stereo miniplug cable) is available from computer or electronics dealers.

1. Connect one end of the audio cable to the **Audio In** port on the projector.

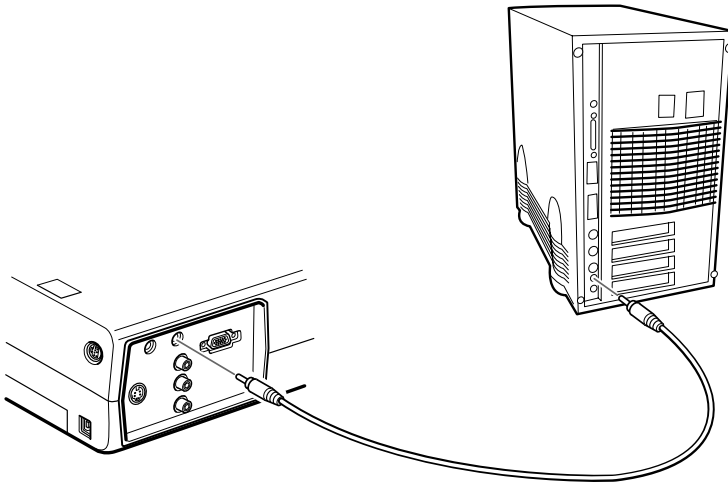

2. Connect the other end of the audio cable to the speaker or audio-out jack on the Macintosh.

Connecting to a High-End Workstation

Your PowerLite projector is capable of remapping input resolutions up to 1600×1200 pixels (1280×1024 pixels on the PowerLite 505c). Since 1280×1024 pixels is the default resolution for most leading workstations, your projector is ideal for displaying workstation video output.

There is no standard for workstation video output. Workstations that follow the SXGA standard and use the HD15 (standard VGA) connector won't need an adapter cable or any special connection device. However, your system may vary; contact your computer dealer if you need help connecting your workstation.

B

Appendix B: Notices

This appendix includes safety instructions and other important information about your EPSON PowerLite 505c/715c.

Important Safety Instructions

Follow these safety instructions when setting up and using the projector:

- Do not place the projector on an unstable cart, stand, or table.
- Do not use the projector near water or sources of heat.
- Use attachments only as recommended.
- Use the type of power source indicated on the projector. If you are not sure of the power available, consult your dealer or power company.
- Place the projector near a wall outlet where the plug can be easily unplugged.

Placez le projecteur près d'une prise de contact où la fiche peut être débranchée facilement.

- Insert the projector's three-wire grounding-type plug into a properly grounded outlet. If you have a two-prong outlet, contact an electrician to replace it. Do not hold the plug with wet hands.
- Take the following precautions for the plug. Failure to comply with these precautions could result in sparks or fire: Do not insert the plug into an outlet with dust present. Insert the plug firmly into the outlet.
- Do not overload wall outlets, extension cords, or integral convenience receptacles. This can cause fire or electric shock.

- Do not place the projector where the cord can be walked on. This may result in fraying or damage to the plug.
- Unplug the projector from the wall outlet before cleaning. Use a damp cloth for cleaning. Do not use liquid or aerosol cleaners.
- Do not block the slots and openings in the projector case. They provide ventilation and prevent the projector from overheating. Do not operate the projector on a sofa, rug, or other soft surface, or in a closed-in cabinet unless proper ventilation is provided.
- Never push objects of any kind through cabinet slots. Never spill liquid of any kind into the projector.
- Except as specifically explained in this *User's Guide*, do not attempt to service this product yourself. Refer all servicing to qualified service personnel. Opening or removing covers may expose you to dangerous voltages and other hazards.
- Unplug the projector during lightning storms or when it will not be used for extended periods.
- Do not place the projector and remote control on top of heat-producing equipment or in a hot location.
- Unplug the projector from the wall outlet and refer servicing to qualified service personnel under the following conditions: When the power cord or plug is damaged or frayed. If liquid has been spilled into the projector, or if it has been exposed to rain or water. If it does not operate normally when you follow the operating instructions, or if it exhibits a distinct change in performance, indicating a need for service. If it has been dropped or the housing has been damaged.
- If you use the projector in a country other than where you purchased it, use the correct power cord for that country.
- Do not stand on the projector or place heavy objects on it.
- Do not attempt to remove the lamp immediately after use. Allow the lamp to cool for approximately one hour before removing it.
- Do not use the projector outside of the required temperature range (41 to 95 °F). Doing so may cause an unstable display and an excessive load on the fan, leading to projector damage.

- Do not store the projector outside of the required temperature range (14 to 140 °F) or in direct sunlight for long periods of time. Doing so may cause damage to the case.
- Do not use the projector with the lens cap in place. The heat generated by the lens may damage the cap.
- The liquid crystal display panel contains more than 99.99% active pixels. However, 0.01% of the pixels may be missing or constantly illuminated.

Remote Control Information

You can operate the projector by remote control via a line-of-sight infrared (IR) receiver at the front and rear of the projector. The projector may not respond to remote control commands under the following conditions:

- There is an object between the remote control IR emitter and the IR receiver on the projector.
- Ambient light is too bright.
- Certain types of fluorescent lighting are used.
- A strong light source shines into the IR receiver.
- Other equipment that emits infrared energy, such as a radiant room heater, is in the room.

These conditions commonly cause problems for most infrared-controlled equipment. Try the following:

- The remote control unit's batteries may be low on power; replace them.
- Dim the ambient lighting and/or turn off any fluorescent lights.
- Close any window coverings and/or move the projector out of direct sunlight.
- Turn off other equipment that emits infrared energy.

If the remote control still does not work correctly, you can always run your computer-based presentation directly from the computer.

Declaration of Conformity

According to 47CFR, Part 2 and 15

Class B Personal Computers and Peripherals; and/or
CPU Boards and Power Supplies used with Class B
Personal Computers

We: EPSON AMERICA, INC.
Located at: 3840 Kilroy Airport Way
MS: 6-43
Long Beach, CA 90806-2469
Tel: (562) 290-5254

Declare under sole responsibility that the product identified herein, complies with 47CFR Part 2 and 15 of the FCC rules as a Class B digital device. Each product marketed, is identical to the representative unit tested and found to be compliant with the standards. Records maintained continue to reflect the equipment being produced can be expected to be within the variation accepted, due to quantity production and testing on a statistical basis as required by 47CFR §2.909. Operation is subject to the following two conditions: (1) this device may not cause harmful interference, and (2) this device must accept any interference received, including interference that may cause undesired operation.

Trade Name: EPSON
Type of Product: LCD Projector
Model: EMP-505/715, ELP-505/715

FCC Compliance Statement

For United States Users

This equipment has been tested and found to comply with the limits for a Class B digital device, pursuant to Part 15 of the FCC Rules. These limits are designed to provide reasonable protection against harmful interference in a residential installation. This equipment generates, uses, and can radiate radio frequency energy and, if not installed and used in accordance with the instructions, may cause harmful interference to radio or television reception. However, there is no guarantee that interference will not occur in a particular installation. If this equipment does cause interference to radio and television reception, which can be determined by turning the equipment off and on, the user is encouraged to try to correct the interference by one or more of the following measures:

- Reorient or relocate the receiving antenna.
- Increase the separation between the equipment and receiver.
- Connect the equipment into an outlet on a circuit different from that to which the receiver is connected.
- Consult the dealer or an experienced radio/TV technician for help.

WARNING

The connection of a non-shielded equipment interface cable to this equipment will invalidate the FCC Certification of this device and may cause interference levels which exceed the limits established by the FCC for this equipment. It is the responsibility of the user to obtain and use a shielded equipment interface cable with this device. If this equipment has more than one interface connector, do not leave cables connected to unused interfaces. Changes or modifications not expressly approved by the manufacturer could void the user's authority to operate the equipment.

For Canadian Users

This Class B digital apparatus meets all requirements of the Canadian Interference-Causing Equipment Regulations.

Cet appareil numérique de la classe B respecte toutes les exigences du Règlement sur le matériel brouilleur du Canada.

C

Appendix C: Technical Specifications

General

Type of display	Poly-silicon Thin Film Transistor (TFT)
Size of LCD panels	Diagonal: 0.9 inches (22.9 mm)
Lens	F=2.0 to 2.2, f=35 to 42 mm
Resolution	715c: 1024 × 768 pixels (native format) 505c: 800 × 600 pixels (native format)
Color reproduction	24 bit, 16.7 million colors
Brightness	715c: 1200 lumens (ANSI) 505c: 1100 lumens (ANSI)
Contrast ratio	400:1
Image size	26 to 300 inches
Projection distance	3.6 to 45.5 feet (1.1 to 13.8 meters)
Projection methods	Front, rear, upside-down (ceiling mount)
Internal sound system	1W monaural
Optical aspect ratio	4:3 (horizontal : vertical)
Zoom ratio	1:1.2
Noise level	42 dB
Keystone correction angle	± 15° (maximum)
Card slot	PCMCIA Type II
Card	Supports CFA specification CompactFlash, SmartMedia, Memory Stick, ATA flash (both 3.3 V and 5 V), and Microdrive

Projection Lamp

Type	UHE (Ultra High Efficiency)
Power consumption	150 W
Lamp life	About 1000 hours
Part number	ELPLP14

Remote Control

Range	32.8 feet (10 meters)
Batteries	Alkaline AA (2)

Mouse Compatibility

Supports PS/2, USB, ADB

Dimensions

Height	2.8 to 3.4 inches (72 to 87 mm)
Width	8.4 inches (213 mm)
Depth	10.5 inches (267 mm)
Weight	6 lb (2.7 kg)

Electrical

Rated frequency	50/60 Hz
Power supply	100 to 120 VAC, 1.9 A 200 to 240 VAC, 1.0 A
Power consumption	Operating: 230 W Standby: 5 W

Environmental

Temperature	Operating: 41 to 95 °F (5 to 35 °C) Storage: 14 to 140 °F (-10 to 60 °C)
Humidity	Operating: 20 to 80% RH, non-condensing Storage: 10 to 90% RH, non-condensing

Safety

United States	FCC Part 15B Class B UL1950 Rev. 3
Canada	DOC ICES003 Class B CSA C22.2 No. 950 Rev. 3
CE Marking	Directive 89/336/EEC, 92/31/EEC EN 60950

Compatible Video Formats

The projector supports NTSC, HDTV, PAL, and SECAM international video standards, as well as the monitor display formats listed below.

To project images output from a computer, the computer's video card must be set at a refresh rate (vertical frequency) that's compatible with the projector; see the following table for compatible formats. As noted below, some images are automatically resized to display in one of the projector's "native" formats (such as XGA). In addition, the frequencies of some computers may not allow images to display correctly; see your computer's documentation for details.

Mode	Refresh Rate (Hz)	Resolution
VGAEGA	70	640 × 350
VGA60	59.94	640 × 480
VGA72	72.809	640 × 480
VGA75	75	640 × 480
VGA85	85.008	640 × 480
VGA Text	70.087	720 × 350
VGA Text	70.087	720 × 400
SVGA56	56.25	800 × 600
SVGA60	60.317	800 × 600
SVGA72	72.188	800 × 600
SVGA75	75	800 × 600
SVGA85	85.061	800 × 600
XGA43i	43.476	1024 × 768 ¹
XGA60	60.004	1024 × 768 ¹
XGA70	70.069	1024 × 768 ¹
XGA75	75.029	1024 × 768 ¹
XGA85	84.997	1024 × 768 ¹
SXGA1—70	70.012	1152 × 864 ²
SXGA1—75	75	1152 × 864 ²
SXGA1—85	84.999	1152 × 864 ²
SXGA2—60	60	1280 × 960 ²
SXGA2—75	75	1280 × 960 ²

Mode	Refresh Rate (Hz)	Resolution
SXGA2—85	85.002	1280 × 960 ²
SXGA3—43i	43.436	1280 × 1024 ²
SXGA3—60	60.02	1280 × 1024 ²
SXGA3—75	75.025	1280 × 1024 ²
SXGA3—85	85.024	1280 × 1024 ²
UXGA60	60	1600 × 1200 ³
MAC II 13	66.67	640 × 480
MAC16	75.087	832 × 624 ¹
MAC19—60	59.28	1024 × 768 ¹
MAC19	74.93	1024 × 768 ¹
MAC21	75.062	1152 × 870 ²
HDTV525I	59.94	640 × 480 ²
HDTV525P	59.94	640 × 480 ²
HDTV750P	60	1280 × 720 ²
HDTV1125I	60	1920 × 1080 ²
HDTV71125I	50.04	1920 × 1080 ²
HDTV1125P	60	1920 × 1080 ²
HDTV1125P	50	1920 × 1080 ²
NTSC	60	640 × 480 ²
PAL	50	720 × 540 ²
SECAM	50	720 × 540 ²

¹ The image is resized so that it displays using one of the projector's native formats (PowerLite 505c only).

² The image is resized so that it displays using one of the projector's native formats.

³ Not supported on the PowerLite 505c.

Computer Video Port Pin Assignments

The Computer port is a female video RGB, 15-pin micro-D-style connector. Here are its pin assignments:

Pin no.	Computer port
1	Red video
2	Green video
3	Blue video
4	Monitor (ID bit 2)
5	GND
6	Red video GND
7	Green video GND
8	Blue video GND
9	+5 V
10	Synchronous GND
11	Monitor (ID bit 0)
12	SDA
13	Horizontal sync
14	Vertical sync
15	Reserved

Index

A

- A/V Mute button, 33, 78
- A/V Mute setting, 80
- About menu, 70, 81
- Accessories, 8, 104
- Adapters, Macintosh, 8, 111 to 112
- Adobe Acrobat Reader, 3 to 4
- Advance setting, 49 to 50, 63 to 64
- Advanced menu, 70, 80 to 81
- Air filter, cleaning and replacing, 85
- Anti-theft device, 8, 11
- Aspect ratio, 121
- ATA flash cards, 41
- Audio
 - adjusting tone, 74 to 75
 - adjusting volume, 32, 74 to 75
 - cables, 6
 - connecting desktop, 110, 113
 - connecting laptop, 14
 - connecting video device, 16 to 18
 - menu, 70, 74 to 75
 - outputting to external sound system, 106 to 107
 - problems, troubleshooting, 99
 - turning off (using A/V Mute), 33
- Audio Out jack, 107
- Auto button, 73
- Auto Setup setting, 74
- Autorun setting, 52 to 53
- AV cable, 15 to 18

B

- Background color setting, 47, 63 to 64
- Bar tool
 - customizing, 76
 - using, 37
- Bass, adjusting, 74 to 75
- Batteries, installing, 30
- Bitmap (BMP) files, 47 to 49

- Blurry image, 97
- BNC cables, 7
- Box tool
 - customizing, 76
 - using, 36
- Brightness, 1, 121
- Brightness setting, 73

C

- Cables, 6 to 8
- Camcorder, connecting to, 15 to 18
- Cancel icon, 60
- Capture menu, 65, 70
- Carrying case, 8, 88
- CD-ROMs, 4
- Ceiling mount, 8, 81, 106
- Cell menu, 49 to 50
- Cleaning
 - air filter, 85 to 86
 - lens, 84
 - projector case, 84
- Color
 - adjusting, 74, 81
 - problems, 98
- Comp button, 32, 99
- CompactFlash memory cards, 41
- Component video cable, 7, 8, 15
- Composite video cable, 15
- Computer cable, 6
- Computer connector pin assignments, 126
- Computers supported, 1
- Connecting projector
 - to a computer with USB cable, 42
 - to a desktop Macintosh, 111 to 113
 - to a desktop PC, 107 to 110
 - to a high-end workstation, 113
 - to a laptop, 12 to 14
 - to a video source, 15 to 18
- Connector pin assignments, 126
- Continuous Play setting, 53, 61, 63 to 64

Contrast setting, 73
Cursor speed, setting, 76
Cursor/Stamp tool
 customizing, 76
 using, 36

D

Declaration of Conformity, 118
Default settings, restoring, 71, 82
Desktop adapter, Macintosh, 111 to 112
Desktop computer, connecting to, 107 to 113
Digital camera, connecting to, 15 to 18
Display order setting, 63 to 64
Display/Hide icon, 59
Distance from projector to screen, 10, 121
Drawing on the screen, 35 to 37
DVD player, connecting to, 15 to 18

E

EasyMP
 button, 32, 56
 CD-ROM, 42, 43
 creating presentations, 39 to 54
 creating scenarios, 44 to 51
 error messages, 102
 installing, 43
 main screen, 56 to 57
 options settings, 63 to 64
 presentations, 56 to 57
 previewing slides, 62 to 63
 problems, 101 to 102
 removing demo, 53
 transferring scenarios to memory card,
 52 to 54
 using on the projector, 55 to 67
 using remote control, 38
EditScenario icon, 58
Effect menu, 70, 75 to 76
Electrical specifications, 122
EMP SlideMaker
 Cell menu, 49 to 50
 computer access, adding, 50 to 51
 creating scenarios, 44 to 51

dragging and dropping PowerPoint files,
 44 to 45
installing, 43
screen, 46
Source Control, 50 to 51
transferring scenarios to memory card,
 52 to 54
 video access, adding, 50 to 51
Enter button, 31
Environmental specifications, 123
EPSON
 accessories, 8, 104
 PrivateLine Support, 5, 103
 technical support, 4 to 5, 103 to 104
Error messages, EasyMP, 102
Esc button, 38
Execute icon, 57, 60, 61
External speakers, connecting to, 106 to 107
E-Zoom button, 33

F

FCC compliance statement, 119
Filter
 See Air filter
Focusing, 25
Foot release levers, 25
Freeze button, 33

G

Gamma setting, 74

H

Height of image, adjusting, 25
Help, 4 to 5, 103 to 104
Help button, 90
Help system, using, 90
Highlighting tools, 35 to 37

I

iBook, connecting to, 12
iMac, connecting to, 7

Image
adjusting, 24 to 26, 72 to 74
capturing and saving in projector, 77
capturing and saving on memory card,
65 to 67
correcting shape of, 26, 79, 96
focusing, 25
height, adjusting, 25
positioning, 25, 73
previewing captured, 66 to 67
problems with, troubleshooting, 94 to 98
raising, 25
resizing, 34
shape, correcting, 26, 79, 96
size and projection distance, 10
size range, 121
turning off (using A/V Mute), 33
zooming, 25, 33

Input signal setting, 74

Installing
EasyMP, 43
USB driver, 42

Installing projector, 106 to 107

J

JPEG files, 47 to 49

K

Kensington anti-theft device, 8, 11
Keystone button, 26
Keystone correction, 26, 96, 121

L

Lamp
automatic shutoff, 27
number of hours used, 81
replacing, 86 to 88
specifications, 122
status light, 91

Language setting, 81, 90

Laptop computer
connecting to, 12 to 14
displaying on, 24, 95

Laser disc player, connecting to, 15 to 18

Lens

cap, 21
cleaning, 84
extending, 20
specifications, 121

Light button (on remote control), 30

Lights, status, 91 to 94

Lines, drawing on screen, 37

Logo, saving on projector, 77 to 79

M

Macintosh, connecting to, 111 to 113

Manuals, 3 to 5

Memory card
accessing, 40 to 42, 52 to 54
compatible card types, 41
inserting in projector, 54
problems, 101
removing from computer, 54
removing from projector, 40 to 41
saving images on, 65 to 67
transferring scenarios, 52 to 54

Memory Stick, 41

Menus

About, 70, 81
Advanced, 70, 80 to 81
Audio, 70, 74 to 75
Capture, 65, 70
changing settings, 70 to 71
Effect, 70, 75 to 76
Reset All, 70, 82
Setting, 70, 79 to 80
using, 70 to 71
Video, 70, 72 to 74

Microdrive, 41

Monitor adapter, Macintosh, 111 to 112

N

No-Signal Msg setting, 78, 79

O

- Options for projector, 8
- Options icon, 61, 63

P

- P in P (picture in picture) button, 34 to 35
- PC card
 - adapter, 41
 - reader, 41, 52
- PCMCIA slot, 41, 52
- Picture
 - See* Image
- Picture-in-picture video source, selecting, 79
- Pin assignments, connector, 126
- Pointer tool
 - customizing, 76
 - using, 36
- Positioning image, 25, 73
- Positioning the projector, 10 to 11, 106
- Power
 - button, 21
 - consumption, 122
 - saving, 27, 80
 - status light, 91, 93
 - supply, 122
- PowerBook, connecting to, 12 to 14
- PowerPoint files
 - adding slides to a scenario, 47 to 49
 - dragging and dropping, 44 to 45
 - problems, 101
- Presentations
 - computer access, adding, 50 to 51
 - Continuous Play, 61, 63 to 64
 - creating for EasyMP, 39 to 54
 - dragging and dropping, 44 to 45
 - EasyMP, 56 to 57
 - rearranging, 49
 - slides, adding, 47 to 49
 - transferring to memory card, 52 to 54
 - transitions, 49 to 50
 - video access, adding, 50 to 51

- Presenters Online, 4, 103
- Preview icon, 62
- PrivateLine Support, 5, 103
- Problems

- color, 98
- EasyMP, 101 to 102
- image, 94 to 98
- remote control, 100, 117
- sound, 99
- USB, 100

- Projection lamp
 - See* Lamp

- Projector
 - carrying case, 8, 88
 - cleaning, 84
 - distance from screen, 10, 121
 - feet, adjusting height with, 25
 - installing, 106 to 107
 - lamp specifications, 122
 - options, 8
 - positioning, 10 to 11
 - resolution, 1, 121
 - shutting off, 27
 - software, 4
 - specifications, 121 to 126
 - transporting, 88
 - troubleshooting, 89 to 99
 - turning off, 27
 - turning on, 20 to 22
 - unpacking, 6 to 7
 - viewing information about, 81

- Prompt setting, 80
- PS/2 mouse cable, 6
- Public address system, connecting to, 106 to 107

R

- Raising image, 25
- RCA AV cable, 15 to 18
- Rear-screen projection, 81, 106
- Registration, 5

- Remote control
 - EasyMP, using for, 38
 - light button, 30
 - numbered buttons, 35
 - problems, 100, 117
 - specifications, 122
 - troubleshooting, 100, 117
 - turning on, 30
 - using, 29 to 38
 - wireless mouse, using as, 38
 - Replacing lamp, 86 to 88
 - Reset All menu, 70, 82
 - Resetting menu options, 71, 82
 - Resize button, 34
 - Resizing image, 34
 - Resolution, 1, 121
 - Return icon, 60, 61
- ## S
- Safety instructions, 115 to 117
 - Scenarios
 - adding slides, 47 to 49
 - background color, 47, 63 to 64
 - cells, 48
 - computer access, adding, 50 to 51
 - Continuous Play, 61
 - creating, 44 to 51
 - default location, 47
 - dragging and dropping PowerPoint files, 44 to 45
 - editing on the projector, 58 to 64
 - exiting, 57
 - presenting on the projector, 56 to 57
 - previewing slides, 62 to 63
 - problems, 101
 - rearranging, 49
 - running automatically, 52 to 53
 - Source Control, 50 to 51
 - transferring to memory card, 52 to 54
 - transitions, 49 to 50
 - video access, adding, 50 to 51
 - Screen image
 - See* Image
 - Screen switching time setting, 49 to 50, 63 to 64
 - Screen, distance from projector, 10, 121
 - Screens, portable, 8
 - Setting menu, 70, 79 to 80
 - Sharpness setting, 74
 - .SIC files, 45, 52, 101
 - .SIT files, 52, 57, 101
 - Sleep mode, 27, 80
 - Slides
 - displaying manually, 57
 - displaying thumbnails, 62
 - hiding, 58 to 60
 - previewing, 62 to 63
 - rearranging, 58 to 60
 - setting options, 63 to 64
 - SmartMedia cards, 41
 - Software, 4
 - Sound
 - adjusting tone, 74 to 75
 - adjusting volume, 32, 74 to 75
 - problems, troubleshooting, 99
 - See also* Audio
 - turning off (using A/V Mute), 33
 - Source button, 22
 - Source Control, inserting, 50 to 51
 - Source, selecting, 32
 - Speaker, specifications, 121
 - Speakers, connecting to, 106 to 107
 - Special effects buttons, 35 to 37
 - Special effects, adding to slide transitions, 49 to 50
 - Specifications
 - brightness, 1, 121
 - electrical, 122
 - environmental, 123
 - general, 121
 - lamp, 122
 - lens, 121
 - remote control, 122
 - resolution, 1, 121
 - safety, 123
 - Spotlight tool
 - customizing, 76
 - using, 37

Startup Screen setting, 81
Startup screen, creating, 77 to 79
Status lights, 91 to 94
Stopping action, 33
Support
 See Technical support
S-Video button, 32
S-Video cable, 7, 15
Sync, adjusting, 73

T

Technical support, 4 to 5, 103 to 104
Temperature
 requirements, 123
 status light, 91
Thumbnail slide images, 62
Tint setting, 74
Tone setting, 74 to 75
Tracking, adjusting, 73
Transporting projector, 88
Treble, adjusting, 74 to 75
Troubleshooting
 EasyMP problems, 101 to 102
 image and sound problems, 94 to 99
 projector problems, 89 to 99
 remote control problems, 100
Turning off picture (using A/V Mute), 33
Turning off projector, 27
Turning on projector, 20 to 22

U

Unpacking projector, 6 to 7
USB
 installing driver, 42
 problems, 100, 101
 using cable to access memory card, 42
USB mouse cable, 6

V

VCR, connecting to, 15 to 18
Video
 adding to scenarios, 50 to 51
 button, 32
 display settings, viewing, 81 to 82
 formats, supported, 1, 124 to 125
 menu, 70, 72 to 74
 picture in picture, 79
 selecting source, 32
Video port pin assignments, 126
Video sources, connecting to, 15 to 18
Volume
 adjusting, 32
 button, 32
 setting, 74 to 75

W

Warning lights, 91 to 94
Warranty, 5
Workstations, connecting projector to, 113

Z

Zoom ratio, 121
Zooming image, 25, 33